

**Variety and style –
tailor-made, of course**



Living full of energy



Roth showers for every bathroom

Our glass and complete showers satisfy the most sophisticated requirements for quality, design and comfort. With our extensive range, we offer solutions for every application, room layout and design idea, from a functional shower for your gym or luxurious accessible shower to a glass shower with an elegant frame for your spa.

Our shower systems also feature impressive functionality: thanks to the high degree of prefabrication, our glass and complete showers are extremely easy to install on site.

Roth shower systems have a long tradition: as a pioneer in the area of complete showers, which we have been producing for over 40 years, we are now one of Europe's leading complete shower suppliers.



A close-up photograph of a human hand, palm up, holding the Roth logo. The hand is positioned in the lower-left quadrant of the page, with the fingers slightly curled to support the logo. The background is a dark, textured grey.

Roth

Roth service: qualified, comprehensive and fast

Our Roth service experts are available to answer any questions you may have about your Roth shower, even after you have purchased it! Our extensive field service provides fast support for technical and commercial issues – on your premises. Our employees even enjoy tackling complex challenges!

The high-quality Roth service package includes an after-sales guarantee, 10-year spare parts provision, fast response times and the prompt supply of spare parts. Our services are underpinned by our membership of the Craftsmen's Association of the Zentralverband Sanitär-Heizung-Klima (Central Association of Plumbing, Heating and Air Conditioning, ZVSHK).

For everyone who wants to find out more about Roth Werke and our products, we offer in-house and product training and a comprehensive online service at www.roth-werke.de.



New standards in modern building technology – for over 60 years

For over 60 years, we have constantly been setting new standards in modern building technology with our own research and development department.

Our customers can always rely on our quality promise: all products are manufactured in compliance with DIN EN ISO 9001 and therefore meet the applicable standards.

Roth Werke – Living full of energy

Roth is an international manufacturer of energy and sanitary systems. We are represented across the world with a total of 1.100 employees.

Apart from our high-quality glass and complete showers, we offer products which use renewable energy as well as efficient energy storage and utilisation products and combine them to form complete systems as a single-source provider – Made in Germany.

As a family-owned company, we value business activities geared to our customers' needs, developing the skills of our employees, while also engaging in fair business practices and taking our social responsibilities seriously.

Based on the motto "Living full of energy", we have a responsibility for producing and designing our products in a way that protects the environment and conserves resources. We are also making a commitment to active environmental protection with our unique "Roth eco-energy cycle".



■ **Design trends – Made in Dautphetal**

We work with high profile designers to develop showers with shapes and designs that are state-of-the-art, integrate perfectly into a modern bathroom design and time and again we are the trendsetters in the industry. For example, the first semi-circular shower on the market that can be fully folded away – our "Laguna® Maxi Wave" – was designed by Roth Werke. The wave design for the range of fittings and wave motif and the bathroom decorations for bathrooms with a distinctive style were developed by the Kurz Kurz design studio in Solingen, exclusively for Roth.



■ **Customised made-to-measure showers from the professionals**

The "craftsmen" who make our showers are based at our Dautphetal-Buchenau site. Here, Roth glass and complete showers that are tailored to our customers' individual requirements are developed using state-of-the-art production technology and logistics. Choose your very own design and shape, your favourite glass and, if you wish, a motif, then our Roth specialist consultants will plan your tailor-made shower. Your sanitary specialist will then professionally install your shower on site – speak to them about our high-quality range of glass and complete showers! Roth showers are only available from them –top quality guaranteed.



■ **Experience Roth showers up close**

Would you like to experience our glass and complete showers up close? Our exclusive showroom is open Monday to Friday from 8:30 a.m. to 3 p.m. at our head office in Dautphetal-Buchenau. Of course, you can also experience our Roth showers at one of our numerous displays throughout Germany. We would be happy to provide you with information about displays near you – give us a call!

■ **Enjoyable showering for many years**

With the Roth brand, you receive certified top quality. If you use and maintain your Roth shower properly, you will be guaranteed many years of enjoyable showering – please read our instructions for use and maintenance.

■ **Certified single-pane safety glass:
extremely robust and resilient**

Roth only uses single-pane safety glass in compliance with DIN EN 12150. The thermally toughened glass has a high degree of resistance to bending, shock and impact loads and is also resistant to changes in temperature. However, if the glass does break, a very rare event, the single-pane safety glass breaks into small, harmless pieces.

■ **Quality tests under extreme conditions**

A Roth glass shower only makes it into our range after it has successfully been subjected to extreme tests. For example, the door parts in our prototype are opened and closed thousands of times and must prove their quality in the long time test. Our glass shower parts are also put through their paces: swinging tests with heavy sand bags ensure that the glass is extremely resilient and resistant to loads and that the frame is stable. If these and other tests are passed, a glass shower meets the top quality requirements of the Roth brand.

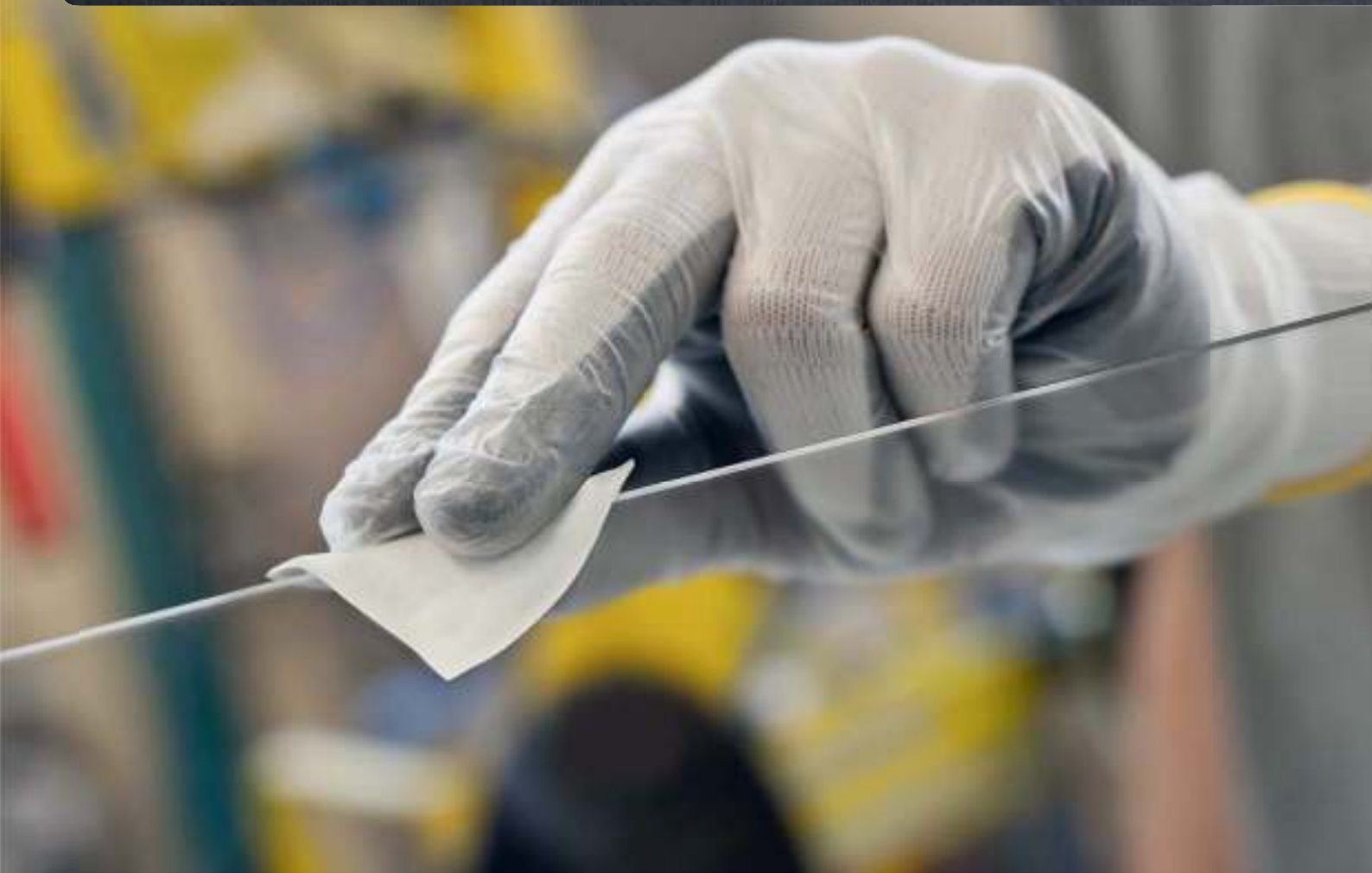

Roth makes your bathroom dreams come true!

Our glass and complete showers provide solutions for every bathroom, from the transparent glass shower or pleasant "room in a room" shower solution to the compact gym shower – Roth showers impress with their combination of reliable functionality and maximum comfort!





Roth Sanitary Systems

■ Roth Glass Showers

Roth Glass Showers	10 - 11
Alina®	12 - 17
Bathroom Decorations	18 - 21
Laguna® Maxi Wave	22 - 43
Mirastar	44 - 45
Cariba®	46 - 55
Cariba Room®	56 - 59
Laguna®	60 - 69
Gala® P.	70 - 73

■ Roth Complete Showers

Roth Complete Showers	76 - 79
Premium line Tempofit	80 - 87
Classic line Exklusiv	88 - 93
Basic line Tempo	94 - 97

■ Design, Dimensions, Technical Data

Design, Dimensions, Technical Data	98 - 99
Glass Showers	100 - 125
Complete Showers	126 - 137

■ References 138

① Bathroom Renovation with Roth Floor Heating and Cooling Systems	74 - 75
---	---------

Roth Glass Showers

The perfect combination of functionality, comfort and elegance

Make your bathroom dreams come true. Roth glass showers combine a high level of functionality and maximum comfort with clear-cut lines, comfortable spaciousness and elegant transparency.

Variety and style – tailor-made, of course

The extensive Roth glass shower range has a solution for every bathroom: every layout, every design idea and every application.

With Roth's Alina®, Laguna® Maxi Wave, Cariba®, Laguna® and Gala® P lines, you will have a glass shower tailor-made for your personal showering pleasure – see for yourself!





Alina®

The new swing fitting range creates a stylish impression

NEW



■ AE3



■ Customisable individuality

The new Roth Alina® glass shower with designer swing fitting is available with a wide variety of doors for customised shower areas. With a 180 degree radius, the extra-flat fitting offers perfect swinging convenience.

Customised designs, tailored to fit even difficult spaces such as rooms with diagonals, are a particular strength of the Roth brand.

The showers are made of 8-mm thick single-pane safety glass – with optional ETC coating (Easy To Clean). They can be fitted onto a shower tray or tiled floor.

The wide variety of options in the range include niche and corner solutions up to 1500 mm in width, bath tub screens and walk-in solutions. Roth bathroom decorations or mirrored Mirastar glass panels are available.

Alina®

Clear design – state-of-the-art and timeless



■ **Bow-type handle**

The elegant bow-type handle fits the hand neatly and adds a stylish touch to your bathroom.



NEW



Alina® handle

Manufactured with precision and attention to detail, our Alina® handles highlight the high-quality design of our Roth showers.

Alina®

Extra-flat fitting for perfect swinging convenience

■ Swing fitting between the door and the fixed element

The extra-flat fitting with an installation height of just 7 mm is ideally suited to modern bathroom designs.



■ Swing fitting on the wall side



■ Wall attachment strip

The wall attachment strip, which is optional for shower solutions with fixed glass elements, is suitable for holding single-pane safety glass that is 6 or 8 mm thick. This offers an adjustment range of 30 mm without visible adjusting screws.



■ Fitting on the inside

The Roth Alina® swing fitting is recessed flush into the glass on the inside with a single-point fastening.



NEW

■ Alina® external angle fitting

Required for many installations: your Alina® 90° external angle fitting



Roth Bathroom Decorations

Create stylish bathroom designs



■ Exclusive decorations for bathrooms with a distinctive style

From "sensual and individual" or "modern and minimalist" to "traditional and timeless": Roth Werke offers exclusive decorations for your glass shower to enable you to create your unique bathroom design. Add a personal touch and highlight your own style of living!

NEW



Roth Bathroom Decorations

For a personal touch



■ sensual and individual

The exclusive Roth stone motif for the sensual and individual bathroom style takes its inspiration from nature in the form of stones. It is a little playful and creates a natural environment. Asymmetry is allowed, and even welcomed, with this type of design.



■ modern and minimalist

With an interior designer's eye for a personalised bathroom, Roth is offering a unique pixel decoration for the modern and minimalist bathroom style. The details and materials benefit from consistency and clarity of design while the elements are arranged at right-angles and in a linear fashion.



■ classic and timeless

In the classic and timeless family bathroom, the retro pattern of the Roth motif creates inviting highlights with a balance between straight lines and softness.



■ Stone motif

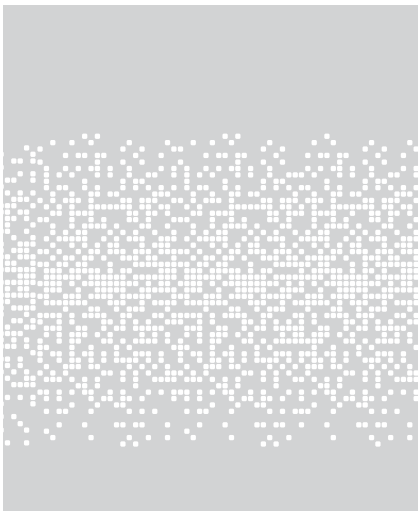

■ Pixel motif

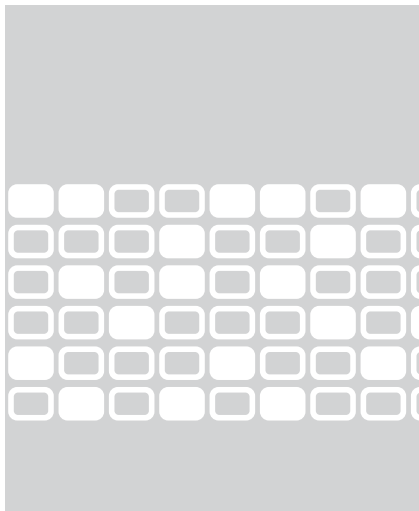

■ Retro motif

Laguna® Maxi Wave

A generously proportioned opening and an impressive finish



■ LMWHK4



A generously proportioned opening and an impressive finish are the distinguishing features of the Roth Laguna® Maxi Wave glass shower.

This is a convenient walk-in shower, installed flush with the floor, with wide foldaway doors and ample space inside. The Laguna® Maxi Wave offers extra special, custom-made comfort, combined with a stylish design for people of all ages.



Laguna® Maxi Wave

The semi-circular shower



The semi-circular Laguna® Maxi Wave HK4F shower, with its fixed side walls and front opening up to a metre wide, will be a real highlight in your bathroom. Even in a small space, you can create your own personal glass shower, which blends elegantly into the room with its unique curved shape.

High-quality genuine glass components and a first-class finish on the handles and fittings round off this premium shower. The semi-circular Laguna® Maxi Wave HK4F shower comes with a standard door height of 2012 mm.



■ LMWR4



■ Roth Laguna® Maxi Wave
four-piece round shower

Laguna® Maxi Wave
Walk-In





The Roth Laguna® Maxi Wave Walk-In offers wide and easy access to the shower. Made-to-measure installations are available in all sizes to suit your requirements.

The panel is secured using a wall attachment strip with an adjustment range of 15 mm to compensate for any unevenness in the wall, or using Wave fittings – whichever you prefer.

The new Roth Unifix retaining tube construction ensures that the panel is securely fixed. The way the glass panel is connected to the wall can be individually adjusted. The Roth Laguna® Maxi Wave Walk-In is made of eight-millimetre-thick single-pane safety glass. It is available in clear glass, in all Roth patterned glass designs or with the wave motif (see section Design, Dimensions, Technical Data). Roth also offers an ETC coating option (Easy to Clean).

Laguna® Maxi Wave

Corner access





Laguna® Maxi Wave
Corner access



■ LMWE3



Laguna® Maxi Wave

Corner access



■ Roth Laguna® Maxi Wave corner access with side wall





■ LMWE5

Laguna® Maxi Wave

Niche



■ LMWS3F

- Roth Laguna® Maxi Wave with two-piece folding door for niche with aligned side wall



Laguna® Maxi Wave

Pentagonal shower

- Roth Laguna® Maxi Wave four-piece pentagonal shower





■ LMWF4

Laguna® Maxi Wave

Adapts to any space



For a tailor-made glass shower in the corner of a room with a window that should be outside the shower, the Roth Laguna® Maxi Wave is the ideal solution. It can even be installed so that the window can still be opened, because the shower is easy to fold away.

After the Roth customer service team has taken the measurements, we will plan the shower area to suit your individual requirements and prepare a tile plan. If there is enough space, a pentagonal shower tray of up to 1000 × 1000 mm is also suitable.



The tried-and-tested pivot/folding door functionality proves its adaptability in many different bathrooms – as it does in the corner of a room with a window. The shower area becomes additional space with the Roth Laguna® Maxi Wave, which also features the impressive double vertical adjustment facility in the door hinge and wall attachment strip.

The angled position of the door part on the wall side on the wall with the window means that you can even have a windowsill.



Laguna® Maxi Wave

The Gecko extra handle



■ **Easiest possible door opening with the Gecko extra handle for the Laguna® Maxi Wave**

The Roth Gecko extra handle is self-adhesive and sticks to the glass surface to allow perfectly easy two-handed operation of the Laguna® Maxi Wave hinged folding doors. Simply press it onto the moving part of the glass door on the inside of the shower and it is immediately ready for use as an extra handle, making it even easier to open the glass doors.



- Using the Gecko is optional – it is also possible to operate the glass doors easily without the extra handle. The Roth Gecko comes as standard with your Roth Laguna® Maxi Wave glass shower.

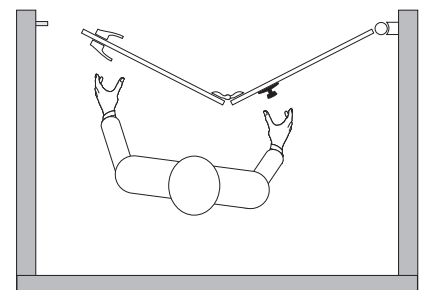

Laguna® Maxi Wave

At a glance

- Can be installed on a tiled floor or a shower tray.
- The doors can be fully folded away, either inwards or outwards against the wall (pivot/folding door mechanism).
- Vertical adjustment facility in the wall attachment strip and door hinge (6 mm in each).
- Standard door height 2000 mm.
- Door hinges are recessed on the inside for greater convenience when cleaning.
- Generous access widths:
 - > corner solutions up to 1500 × 1500 mm
 - > niche doors up to 2500 mm
 - > made-to-measure walk-in option also available
- High-quality materials:
 - > pre-assembled profile pieces and glass fittings
 - > ESG safety glass with optional ETC coating (Easy To Clean)
 - > aluminium profiles
 - > functional parts made of metal





■ LMWB2

Mirastar

Check your appearance in the bathroom



Roth glass showers are now bringing a mirror-like shine into the bathroom. The panes made from single-pane safety glass are available with the full-length Mirastar chrome mirror and also with the wave motif. The enlarging effect of the mirror makes even a small bathroom look more spacious.



■ Cariba® glass shower corner access with fixed Mirastar side wall and wave motif



■ Cariba® glass shower corner access with fixed Mirastar side wall



■ Laguna® glass shower Maxi Wave Walk-In with Mirastar



■ Laguna® glass shower Maxi Wave Walk-In with Mirastar and wave motif

■ **Roth Mirastar at a glance:**

- > Roth Mirastar is a mirror with a chrome-based, multi-layered system. The panels are corrosion-resistant and are not sensitive to water vapour or cleaning products.
- > Mirastar and the wave motif are available for the walk-in products in the range as well as for the fixed side walls (corner solution) in dimensions of up to 1400 mm wide and 2000 mm high, and in 6 mm and 8 mm single-pane safety glass.
- > Dual functionality: spray protection and a full-length mirror.
- > Offers a privacy screen and creates a pleasant private area in the bathroom.
- > Mirastar is translucent under certain lighting conditions.

Cariba®

The brilliantly clear design





■ CE2 and CSW1S

With its brilliant, clear design, Cariba® invites you to relax and drift away. Cariba® offers the perfect configuration for every bathroom.

A choice of corner, curved and pentagonal versions is available, as well as niche and bath tub screen solutions.



Cariba®

Niche

You can add stylish accents of colour to your bathroom with the door handle and wall bracket; they come with a choice of white or chrome-coloured inlays.

■ Door handle

The elegantly proportioned door handle discreetly catches the eye. Its simple D shape makes it easy to grasp.



■ Wall bracket

In addition to stabilising the shower, the practical wall bracket offers added convenience, as it provides space for shower accessories.





■ CP1 and CF1

Cariba®
Walk-In





■ All the models can be assembled with the hinges on the left or the right. The doors open both inwards and outwards, thus making it easy to get in and out of the shower.

The Cariba® range is characterised by the comprehensive choice of door access types. The single-pane safety glass doors are subtly framed by gleaming silver aluminium.

Cariba®

Round shower



■ Vertical adjustment facility

The vertical adjustment facility makes it easy to operate the door. Adjustment is continuous and the door can be opened to any angle.





■ CR2 and CR4

Cariba®

Combination options

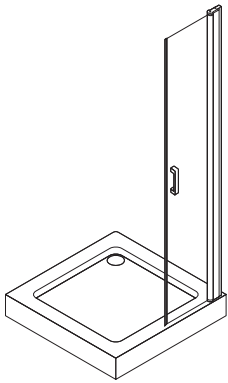

Swing door leaf without fixed element
1 × CP245 (width 450 mm)

+

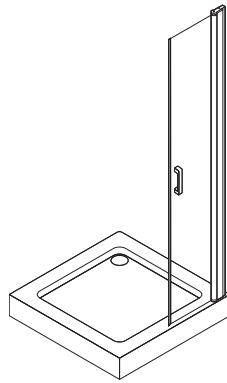

Swing door leaf without fixed element
1 × CP245 (width 450 mm)

=

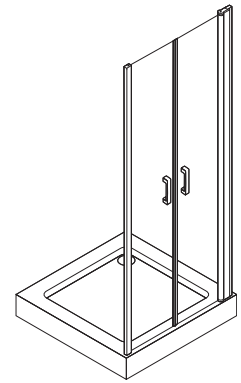

Niche door
2 × CP245 (width 900 mm)

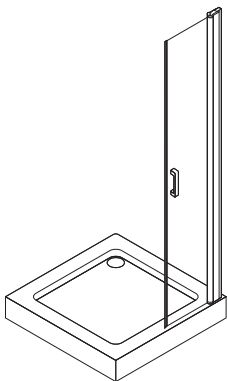

Swing door leaf without fixed element
1 × CP245 (width 450 mm)

+

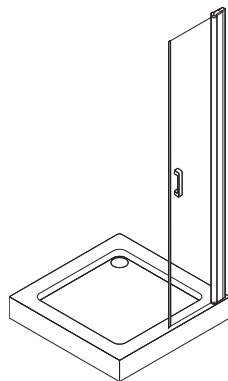

Swing door leaf without fixed element
1 × CP245 (width 450 mm)

+

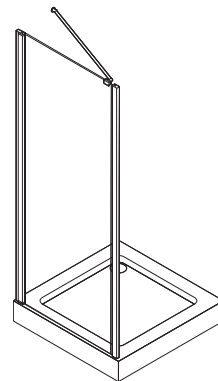

Side wall on the hinged side
1 × C5W1A90 (width 900 mm)

=

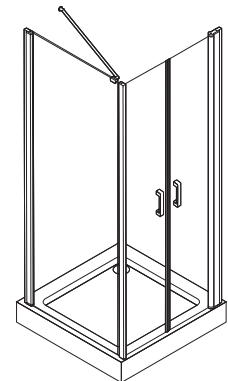

Corner shower
2 × CP245 (width 900 mm) +
1 × C5W1A90 (width 900 mm)



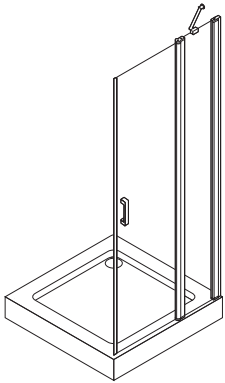

Corner door leaf with fixed element
1 × CE490 (width 900 mm)

+

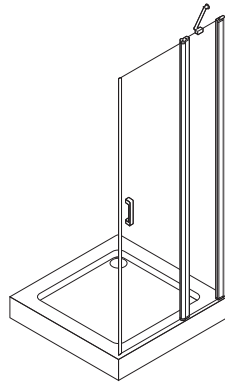

Corner door leaf with fixed element
1 × CE490 (width 900 mm)

+

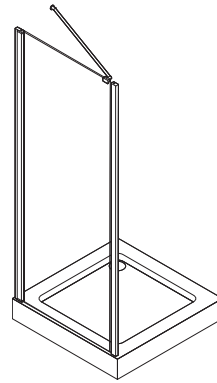

Side wall on the hinged side
1 × CSW1A90 (width 900 mm)

=

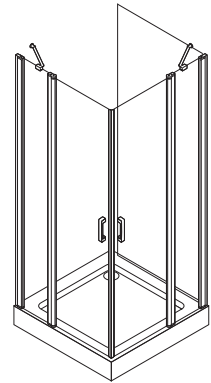

■ Cabin against the wall
2 × CE490 (width 900 mm) +
1 × CSW1A90 (width 900 mm)

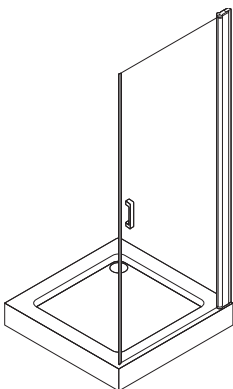

Corner door leaf without fixed element
1 × CE290 (width 900 mm)

+

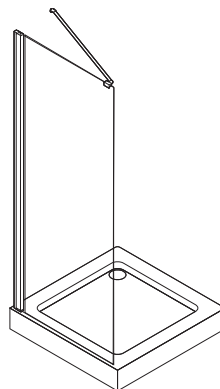

Side wall on the closure side
1 × CSW1590 (width 900 mm)

=

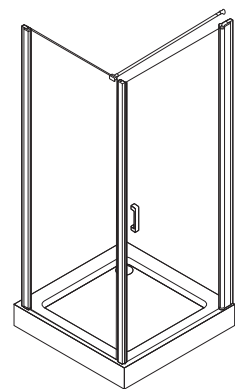

■ Corner shower
1 × CE290 (width 900 mm) +
1 × CSW1590 (width 900 mm)

■ The Roth Cariba® shower line offers many combination options and different shapes and enables shower screens to be created for any space. Corner, curved and pentagonal showers are available, as are niche solutions and bath tub screens.

We would be happy to advise you on designing your customised shower.

Cariba® Room

Comfort in a new form

NEW



■ Spacious showering pleasure

Cariba® Room is the new model in the Roth Cariba® range. The spacious shower unit provides both an area for showering and a multi-purpose vestibule area. The two are connected by a glass door that opens inwards and outwards.

Including the vestibule area in the shower unit creates a convenient, warm and cosy room for drying yourself off after a shower.

With a width of 1800 mm, the Cariba® Room makes an ideal replacement for a bath tub without extensive renovation work. Two fixed glass elements and a door are enough to create a comfortable bathroom.

The Cariba® Room is available with a Roth glass motif or Roth Mirastar glass panels. It can be fitted to both shower trays and tiled shower surfaces.



■ CSW1A, CTF1 and CF1A

Cariba® Room

Including the vestibule area in the shower unit



■ In addition to the Cariba® Room, the Roth Cariba® product line allows many combination options and different shapes. Thanks to the modular construction, shower screens can be created for any space.

Corner, curved and pentagonal showers are available, as are niche solutions and bath tub screens.

The vestibule area provides plenty of space for dressing gowns, towels, seating and storage for shower accessories.

NEW



■ The door position can be altered to create either two separate functional areas or one large shower room.



Laguna®

Elegant handles on wide glass doors



■ LRA2

- Laguna® showers are distinguished by their generously proportioned doors. The elegant bar handles form a visual link between the wide glass doors.



- Laguna® rotatable swing doors with smart technology: easy opening and improved spray protection thanks to the integrated vertical adjustment facility.



■ LR2

Laguna® Pentagonal



■ LFA2



■ Attractive, practical and convenient: the door handle with an integrated shower towel holder.



■ LF2

■ With an access width of 60 cm, the opening angle is markedly smaller because of the asymmetrical panel division on the Laguna® FA pentagonal shower. You will require less space but have more room for access through the narrower door. Maximum access width with a narrower opening angle – perfect for the smaller bathroom.

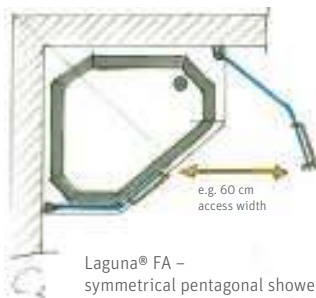

Laguna® FA – symmetrical pentagonal shower

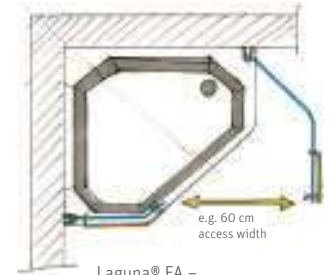

Laguna® FA – asymmetrical pentagonal shower

Laguna®
Corner access



■ LE2



■ The water-repellent ETC (Easy To Clean) coating on the glass panels of all Roth glass showers encourages the formation of droplets, which makes it easier for the water to run off. This makes the shower more hygienic and reduces the effort required for cleaning, as there are fewer deposits of limescale and dirt (available for a surcharge).

Laguna®

Swing door with side wall



■ Easy to adjust





■ LSS2

Laguna®

Harmonious design



■ Whether they form part of a solution for a corner or niche in the bathroom, or a freestanding shower with integral side wall, the various rotatable swing doors in the Laguna® range offer harmonious design combined with a generous access width, even where space is limited.

■ LS1



Gala® P

A combination of functionality, design and economy of use



■ GPR4



- The features of the Gala® P are functionality, design and economy of use.

It is made of high-quality genuine glass for plenty of transparency and has smart fittings combined with a seamlessly integrated wall attachment strip.



- The transparent door seal, together with the profile along the bottom edge, guarantee the best possible protection from spray.

Gala® P

Corner access



■ GPSS3A



■ The functional door handle fits in your hand snugly and securely.



■ The wall attachment strip makes it easy to compensate for discrepancies in the wall up to a maximum of 15 mm.



Bathroom Renovation with Roth Floor Heating and Cooling Systems



Renovating your bathroom?

Roth can offer you innovative floor heating and cooling systems

The floor heating system can be retrofitted without having to go through the dirty and time-consuming process of taking up the floor. The Roth ClimaComfort® Compact System can be installed on an existing subsurface. This ensures minimum installation height combined with maximum reaction speed.

As a specialist in floor heating and cooling systems, Roth provides solutions for modernisation projects which can be installed on existing screed, walls or ceilings.

Is that something that interests you?

You can find more information at www.roth-werke.de

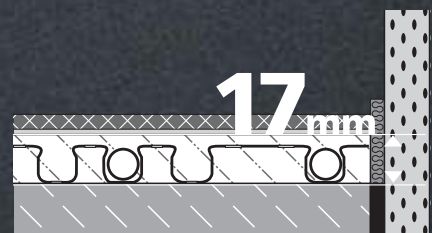

■ Low installation height of 17 mm



Roth Complete Showers

Complete solutions that meet the highest requirements for functionality and custom-made comfort when showering

Roth's complete showers combine sophisticated technology and reliable functionality – and provide you with pleasant and enjoyable showers for years to come!

Comfortable showering that meets your individual requirements

The Roth complete showers adapt flexibly to the design of the room. You can enjoy your shower experience even if a fixed installation is not what you want or is not feasible, for example in holiday homes, gyms and sports rooms, hobby rooms, or even in the bathroom.

Top quality from the complete shower pioneer

As a pioneer, we have been producing complete showers for over 40 years – and are now one of Europe's leading complete shower suppliers. Our customers benefit from our extensive experience gained over many years and can therefore count on our reliable product quality.





Complete Shower Overview

Premium line Tempofit



Classic line Exklusiv



Basic line Tempo



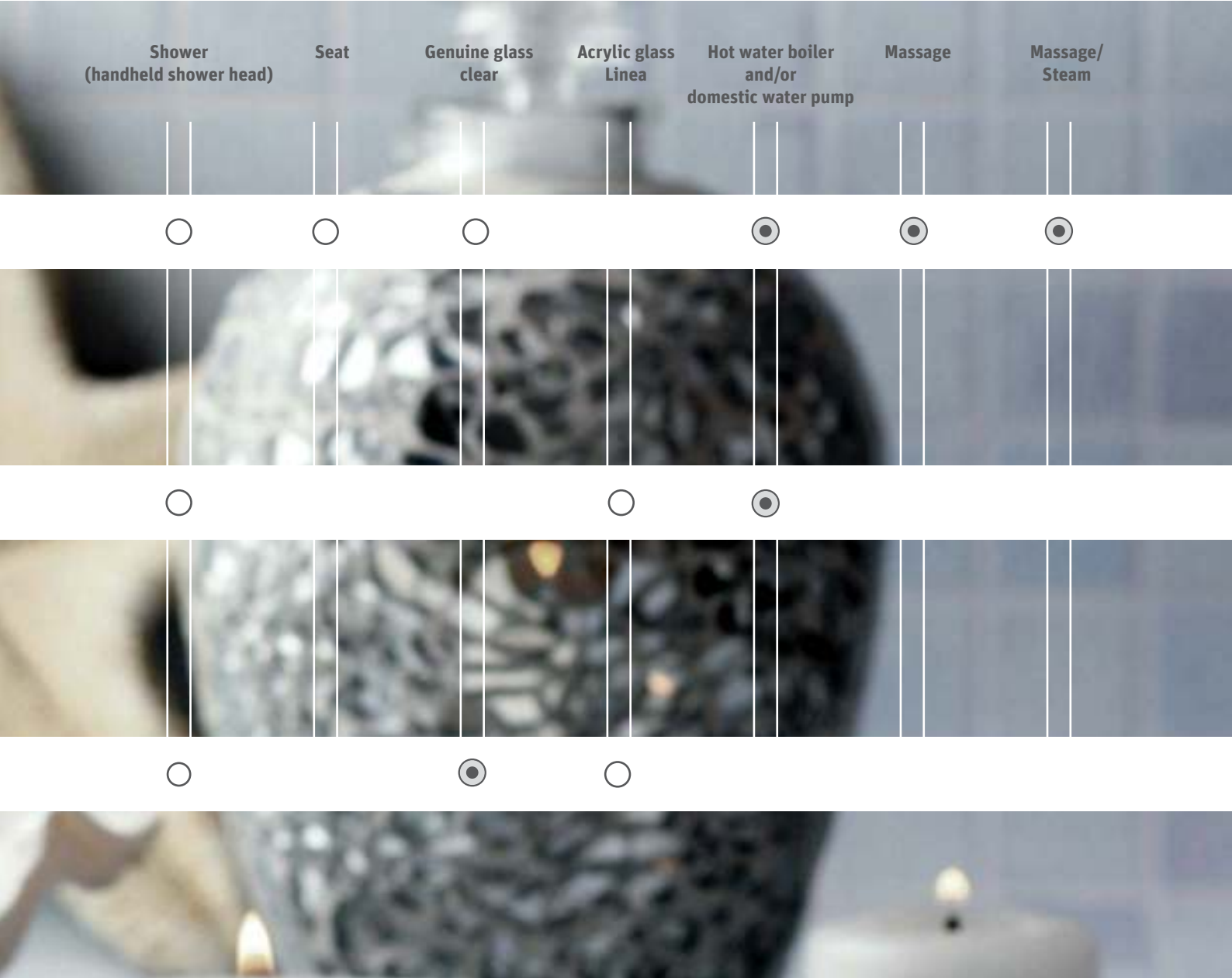

○ = Basic equipment

● = Additional equipment

Subject to technical modifications.

Premium line Tempofit

with compact continuous flow heater and automatic pump



■ Compact continuous flow heater

The Tempofit complete shower is also available with an 11 kW electric compact continuous flow heater. In the basic shower function model, this is already incorporated in the seat panel, ready to be connected. The compact continuous flow heater will supply you with shower water at just the right temperature, straight away and for as long as you like.



■ **Automatic pump**

The automatic pump option is always required wherever natural drainage via a drainage system is not possible. The Roth discharge pump does the job completely automatically. The maximum delivery height is 150 cm.

With the right accessories, waste water, for example from a hand basin, can be fed in.



■ **Hand basin**

Another tap can also be connected next to the hot water supply of the Tempofit complete shower.

Premium line Tempofit

Shower with optional massage and steam functions



■ Tempofit Corner, shower



Cabin height**	Door design	Function description	Mat. no.
2140	Sliding door, 2 pieces*	Shower function	1115007201
2140	Sliding door, 2 pieces*	Shower and massage function	1115007203
2180	Sliding door, 2 pieces*	Shower, massage and steam function	1115007205
2140	Sliding door, 2 pieces*	Shower function with compact continuous flow heater and automatic pump	1115007953
2140	Sliding door, 2 pieces*	Shower function with compact continuous flow heater	1115007954
2140	Sliding door, 2 pieces*	Shower function with automatic pump	1115007952
2180	Swing door, 2 pieces	Shower function	1115007213
2180	Swing door, 2 pieces	Shower and massage function	1115007215
2180	Swing door, 2 pieces	Shower, massage and steam function	1115007217
2180	Swing door, 2 pieces	Shower function with compact continuous flow heater and automatic pump	1115007959
2180	Swing door, 2 pieces	Shower function with compact continuous flow heater	1115007960
2180	Swing door, 2 pieces	Shower function with automatic pump	1115007958
2180	Swing door (l.) with side wall (r.)	Shower function	1115007234
2180	Swing door (l.) with side wall (r.)	Shower and massage function	1115007236
2180	Swing door (l.) with side wall (r.)	Shower, massage and steam function	1115007238
2180	Swing door (l.) with side wall (r.)	Shower function with compact continuous flow heater and automatic pump	1115007971
2180	Swing door (l.) with side wall (r.)	Shower function with compact continuous flow heater	1115007972
2180	Swing door (l.) with side wall (r.)	Shower function with automatic pump	1115007970
2180	Swing door (r.) with side wall (l.)	Shower function	1115007243
2180	Swing door (r.) with side wall (l.)	Shower and massage function	1115007245
2180	Swing door (r.) with side wall (l.)	Shower, massage and steam function	1115007247
2180	Swing door (r.) with side wall (l.)	Shower function with compact continuous flow heater and automatic pump	1115007977
2180	Swing door (r.) with side wall (l.)	Shower function with compact continuous flow heater	1115007978
2180	Swing door (r.) with side wall (l.)	Shower function with automatic pump	1115007976

* without top

** Dimensions in mm

■ Shower

On all Tempofit showers with no compact continuous flow heater, a thermostat mixer with a safety notch at a water temperature of 38 °C comes as standard.

■ Space

The Roth Tempofit provides ample space for standing or sitting and plenty of shelves.



■ Tempofit Corner, shower/massage

■ Style

The seat design is a perfect combination of smooth shape and comfort.

■ Materials

The defining design features of this elegant product are the back and side panels. Like the shower tray, they are made of high-grade, skin-friendly bathroom quality plastic. The doors are made of single-pane safety glass.



■ Tempofit Corner, shower/massage/steam

Premium line Tempofit

Pure relaxation



■ Relaxation

You don't have to go to a health spa to find an oasis of relaxation. You can experience it every day in the shower in your dream bathroom.

■ Massage

Relax with a targeted massage - you can do this in a Tempofit shower with its six adjustable back jets and two adjustable neck jets arranged round the seating area. The massage function can be connected where the water pressure is between 2,0 and 5,0 bar. The recommended water pressure is 3,0 bar.



■ Massage jet

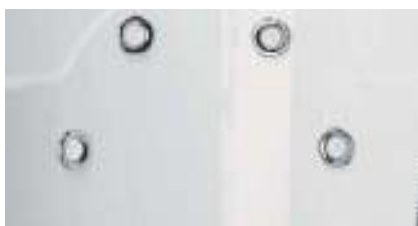

■ Massage jets



■ Tempofit Corner, shower/massage

Model	Cabin height*	Door design	Function description	Mat. no.
Tempofit Corner, 755 × 1020	2180	Swing door (r.) with side wall (l.)	Shower function	1115007240
Tempofit Corner, 755 × 1020	2180	Swing door (r.) with side wall (l.)	Shower and massage function	1115007241
Tempofit Corner, 755 × 1020	2180	Swing door (r.) with side wall (l.)	Shower, massage and steam function	1115007242
Tempofit Corner, 755 × 1020	2180	Swing door (r.) with side wall (l.)	Shower function with compact continuous flow heater and automatic pump	1115007974
Tempofit Corner, 755 × 1020	2180	Swing door (r.) with side wall (l.)	Shower function with compact continuous flow heater	1115007975
Tempofit Corner, 755 × 1020	2180	Swing door (r.) with side wall (l.)	Shower function with automatic pump	1115007973
Tempofit Corner, 1020 × 755	2180	Swing door (l.) with side wall (r.)	Shower function	1115007231
Tempofit Corner, 1020 × 755	2180	Swing door (l.) with side wall (r.)	Shower and massage function	1115007232
Tempofit Corner, 1020 × 755	2180	Swing door (l.) with side wall (r.)	Shower, massage and steam function	1115007233
Tempofit Corner, 1020 × 755	2180	Swing door (l.) with side wall (r.)	Shower function with compact continuous flow heater and automatic pump	1115007968
Tempofit Corner, 1020 × 755	2180	Swing door (l.) with side wall (r.)	Shower function with compact continuous flow heater	1115007969
Tempofit Corner, 1020 × 755	2180	Swing door (l.) with side wall (r.)	Shower function with automatic pump	1115007967

*Dimensions in mm

Premium line Tempofit





■ Seat panel



■ Control button for steam function



■ Fittings panel



■ Tempofit Round, shower/massage

■ Steam

A steam bath in the Tempofit shower will stimulate your circulation and metabolism and cleanse your skin. For an even greater feeling of well-being, essential oils are added through the steam nozzle.

Cabin height**	Door design	Function description	Mat. no.
2140	Sliding door, 2 pieces*	Shower function	1115007207
2140	Sliding door, 2 pieces*	Shower and massage function	1115007209
2180	Sliding door, 2 pieces	Shower, massage and steam function	1115007211
2140	Sliding door, 2 pieces*	Shower function with compact continuous flow heater and automatic pump	1115007956
2140	Sliding door, 2 pieces*	Shower function with compact continuous flow heater	1115007957
2140	Sliding door, 2 pieces*	Shower function with automatic pump	1115007955
2180	Swing door, 1 piece (l.)	Shower function	1115007219
2180	Swing door, 1 piece (l.)	Shower and massage function	1115007221
2180	Swing door, 1 piece (l.)	Shower, massage and steam function	1115007223
2180	Swing door, 1 piece (l.)	Shower function with compact continuous flow heater and automatic pump	1115007962
2180	Swing door, 1 piece (l.)	Shower function with compact continuous flow heater	1115007963
2180	Swing door, 1 piece (l.)	Shower function with automatic pump	1115007961
2180	Swing door, 1 piece (r.)	Shower function	1115007225
2180	Swing door, 1 piece (r.)	Shower and massage function	1115007227
2180	Swing door, 1 piece (r.)	Shower, massage and steam function	1115007229
2180	Swing door, 1 piece (r.)	Shower function with compact continuous flow heater and automatic pump	1115007965
2180	Swing door, 1 piece (r.)	Shower function with compact continuous flow heater	1115007966
2180	Swing door, 1 piece (r.)	Shower function with automatic pump	1115007964

* without top

** dimensions in mm

Classic line Exklusiv

Personalised access

■ The Exklusiv complete shower comes in various sizes, either with a curtain or in the following acrylic glass versions: 1-piece swing door, 2-piece folding door, 3-piece sliding door and 4-piece corner access. It comes with a matching mixer tap, handheld shower head and soap dish, and a hot water boiler and/or pump built into the bottom part of the shower.

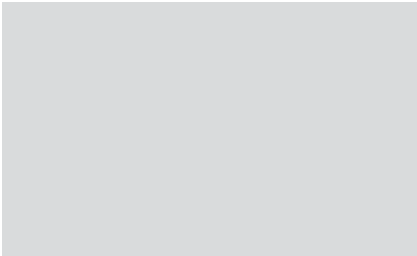

■ Light grey decoration



■ 3-piece sliding door is easy to clean



■ A clever touch: drainage channel sloping inwards on the 1-piece swing door



■ Exklusiv sliding door, 3 pieces

■ Top part

- > Quick assembly system

Door type:

- > Upper closure frame
- > Silver aluminium profiles and Linea acrylic glass motif
- > Plastic back and side walls preassembled with hinged profiles

Curtain type:

- > White curtain
- > Closure frame
- > Plastic profiles
- > Plastic back and side walls preassembled for plug-in installation
- > Also available with transparent side pieces

■ Fittings

- > Wall bar with handheld shower head and shower hose (chrome)
- > Integrated soap dish
- > Two-handle mixer tap (chrome)

■ Bottom part

- > Aluminium frame with steel enamel shower tray (white) and removable covering (silver-grey)

NOTE:

The top part can be shortened.

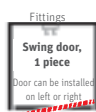
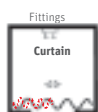

■ Exklusiv swing door, 1-piece door, can be fitted on the left or the right

Roth "Exklusiv" complete shower (top and bottom part)								
Top part design	Outside dimensions (shower tray dim.)		Mat. no.	Mat. no.	Mat. no.	Mat. no.	Mat. no.	Mat. no.
		TP = top part BP = bottom part	without boiler without pump	with boiler without pump	with boiler with pump	without boiler with pump	with boiler and automatic pump	without boiler, with automatic pump
Curtain (not shown)	745 × 745 (700 × 700)	Mat. no. TP Mat. no. BP	1115000118 1115000015	1115000118 1115000018	1115000118 1115000020	1115000118 1115000022	1115000118 1115000025	1115000118 1115000027
	845 × 845 (800 × 800)	Mat. no. TP Mat. no. BP	1115000096 1115000000	1115000096 1115000003	1115000096 1115000005	1115000096 1115000007	1115000096 1115000010	1115000096 1115000012
Swing door, 1 piece	745 × 745 (700 × 700)	Mat. no. TP Mat. no. BP	1115000126 1115000015	1115000126 1115000018	1115000126 1115000020	1115000126 1115000022	1115000126 1115000025	1115000126 1115000027
	845 × 845 (800 × 800)	Mat. no. TP Mat. no. BP	1115000114 1115000000	1115000114 1115000003	1115000114 1115000005	1115000114 1115000007	1115000114 1115000010	1115000114 1115000012
Sliding door, 3 pieces	795 × 845* (750 × 800)	Mat. no. TP Mat. no. BP	1115000134 1115000030	1115000134 1115000033	1115000134 1115000035	1115000134 1115000037	1115000134 1115000040	1115000134 1115000042
	795 × 945* (750 × 900)	Mat. no. TP Mat. no. BP	1115000158 1115000075	1115000158 1115000078	1115000158 1115000080	1115000158 1115000082	1115000158 1115000085	1115000158 1115000087
	845 × 795* (800 × 750)	Mat. no. TP Mat. no. BP	1115000142 1115000045	1115000142 1115000048	1115000142 1115000050	1115000142 1115000052	1115000142 1115000055	1115000142 1115000057
	845 × 845 (800 × 800)	Mat. no. TP Mat. no. BP	1115000104 1115000000	1115000104 1115000003	1115000104 1115000005	1115000104 1115000007	1115000104 1115000010	1115000104 1115000012
	945 × 795* (900 × 750)	Mat. no. TP Mat. no. BP	1115000166 1115000090	1115000166 1115000091	1115000166 1115000092	1115000166 1115000093	1115000166 1115000094	1115000166 1115000095
	945 × 945 (900 × 900)	Mat. no. TP Mat. no. BP	1115000150 1115000060	1115000150 1115000063	1115000150 1115000065	1115000150 1115000067	1115000150 1115000070	1115000150 1115000072

Transparent side walls also available at no extra charge.

*NOTE: The first dimension is the size of the door or opening (dimensions in mm)

Classic line Exklusiv

The classic Roth complete shower



■ Exklusiv folding door,
2 pieces, fitted on the left or right

■ **Exklusiv additional equipment**

- > High-performance hot water boiler (low pressure 230 V/2 kW)
- > Temperature and safety controls with frost protection
- > Pump with two power levels (40 W/150 W), each with/without automatic mode (230 V)
- > Single-lever high-pressure mixer
- > Single-lever low-pressure mixer
- > Flexible connection hoses (3/8") 500 mm or 1250 mm
- > Wall connection cover



■ Truly complete with the additional equipment: available with boiler/pump



■ Quick-fit system, remains movable



■ **Exklusiv corner access**

"Exklusiv" complete shower (top and bottom part)								
Top part design	Outside dimensions (shower tray dim.)		Mat. no.	Mat. no.	Mat. no.	Mat. no.	Mat. no.	Mat. no.
			without boiler without pump	with boiler without pump	with boiler with pump	without boiler with pump	with boiler and automatic pump	without boiler, with automatic pump
Folding door, 2 pieces	745 × 745 (700 × 700)	Mat. no. TP Mat. no. BP	1115000122 1115000015	1115000122 1115000018	1115000122 1115000020	1115000122 1115000022	1115000122 1115000025	1115000122 1115000027
	795 × 845* (750 × 800)	Mat. no. TP Mat. no. BP	1115000130 1115000030	1115000130 1115000033	1115000130 1115000035	1115000130 1115000037	1115000130 1115000040	1115000130 1115000042
	795 × 945* (750 × 900)	Mat. no. TP Mat. no. BP	1115000154 1115000075	1115000154 1115000078	1115000154 1115000080	1115000154 1115000082	1115000154 1115000085	1115000154 1115000087
	845 × 795* (800 × 750)	Mat. no. TP Mat. no. BP	1115000138 1115000045	1115000138 1115000048	1115000138 1115000050	1115000138 1115000052	1115000138 1115000055	1115000138 1115000057
	845 × 845 (800 × 800)	Mat. no. TP Mat. no. BP	1115000100 1115000000	1115000100 1115000003	1115000100 1115000005	1115000100 1115000007	1115000100 1115000010	1115000100 1115000012
	945 × 795* (900 × 750)	Mat. no. TP Mat. no. BP	1115000162 1115000090	1115000162 1115000091	1115000162 1115000092	1115000162 1115000093	1115000162 1115000094	1115000162 1115000095
	945 × 945 (900 × 900)	Mat. no. TP Mat. no. BP	1115000146 1115000060	1115000146 1115000063	1115000146 1115000065	1115000146 1115000067	1115000146 1115000070	1115000146 1115000072
Corner access, 2 pieces, right	845 × 845 (800 × 800)	Mat. no. TP Mat. no. BP	1115000108 1115000000	1115000108 1115000003	1115000108 1115000005	1115000108 1115000007	1115000108 1115000010	1115000108 1115000012
Corner access, 2 pieces, left	845 × 845 (800 × 800)	Mat. no. TP Mat. no. BP	1115000111 1115000000	1115000111 1115000003	1115000111 1115000005	1115000111 1115000007	1115000111 1115000010	1115000111 1115000012



Transparent side walls also available at no extra charge.

*NOTE: The first dimension is the size of the door or opening (dimensions in mm)

Classic line Exklusiv



■ Low access height

The new complete shower, "Exklusiv with a low access height", has an impressively convenient design with a step of just 180 mm to enter the cubicle. The two-piece swing door made of transparent single-pane safety glass emphasises the added convenience for the user with its spacious entrance.

■ Square, practical and complete

The new Exklusiv has a total height of 2050 mm. Practically dimensioned with a width and depth of 845 mm, it fits easily into bathrooms, hobby rooms, holiday homes or allotment sheds – anywhere, where a fixed installation is undesirable or impossible.

■ The thermostat mixer is included, only one cold and hot water connection is required.

■ All 845 × 845 mm top parts from the existing Exklusiv range can be combined with the new bottom part with its low access height. With a total height of 1915 mm, this is the perfect solution for rooms with low ceilings.

NEW



Fittings

The fittings supplied consist of a wall bar with handheld shower head and shower hose, an integrated soap dish and a thermostat mixer.



Bottom part

Access height reduced by 40%. Added convenience for complete showers with a step of just 180 mm.



Exklusiv complete shower with low access					
Description	Material number	Height in mm	Outside dimensions	Shower tray dimensions	Fittings
Exklusiv top part with ESG 2-piece swing door (can only be combined with bottom part 1115009864)	1115009865	1870	845 × 845 mm	800 × 800 mm	with slide rail set
Bottom part with chrome-plated thermostat mixer	1115009864	180	845 × 845 mm	800 × 800 mm	without boiler or pump

Bottom parts with low access to be combined with 1735-mm top parts					
Description	Material number	Height in mm	Outside dimensions	Shower tray dimensions	Fittings
Bottom part with two-handle high-pressure chrome-plated tap	1115009906	180	845 × 845 mm	800 × 800 mm	without boiler or pump
Bottom part with single-level high-pressure chrome-plated mixer	1115009905	180	845 × 845 mm	800 × 800 mm	without boiler or pump

Basic line Tempo

The compact space-saver

■ Bottom part

- > Acrylic shower tray with styropor supports, non-slip floor design, drain diameter 90 mm

■ Top part

- > Single swing door with white aluminium profiles, opening to either left or right, side walls in acrylic glass, Linea motif
- > Double fastening with magnetic seal
- > Bottom door profile with water run-off channel
- > Incorporated into the patterned back wall: soap dish and shampoo shelf with chrome-plated shower head holder
- > Two wall mountings
- > Upper closure frame made of white plastic

■ Fittings

- > Single-lever mixer tap, wall bar with handheld shower head, shower hose (chrome)

■ Option

- > Wall connection cover in white plastic (width 70 mm)



■ Water run-off channel on the door



Tempo 801 PS

Tempo 802 PS

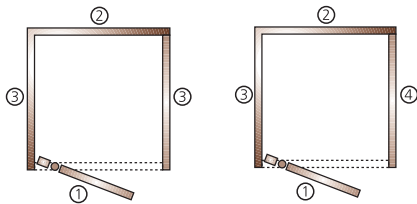

Access width approx. 510 mm

Tempo 801 PS

Two side walls in acrylic glass, Linea motif ③

Tempo 802 PS

Side wall in acrylic glass, Linea ③,
side wall in plastic (white) ④,
side walls can be installed on the right or the left.



■ Genuine glass models

All Tempo models are also available with genuine glass.



Basic line Tempo

with variable access types



■ Tempo 814 PS

■ Bottom part

- > Acrylic shower tray with styropor supports, non-slip floor design, drain diameter 90 mm

■ Top part

- > 2-piece swing door with white aluminium profiles and acrylic glass, side walls in acrylic glass, Linea motif
- > Quadruple fastening with magnetic seal
- > Bottom door profile with water run-off channel
- > Incorporated into the patterned back wall: soap dish and shampoo shelf with chrome-plated shower head holder
- > Two wall mountings
- > Upper closure frame made of white plastic

■ Fittings

- > Single-lever mixer tap, wall bar with handheld shower head, shower hose (chrome)

■ Option

- > Wall connection cover in white plastic (width 70 mm)



- Shampoo shelf incorporated into the patterned back wall

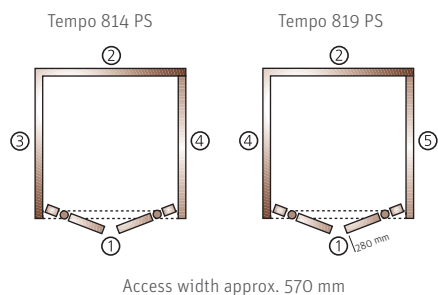

Tempo 814 PS

Side wall in acrylic glass, Linea (3).
 Patterned side wall with top shelf and footrest (4).
 Side walls can be installed on the right or the left.

Tempo 819 PS

Patterned side wall with top shelf and footrest (4),
 side wall with motif in white plastic (5), side walls are
 interchangeable, can be installed on the right or the
 left.

NOTE

With the Tempo complete shower, there may be slight differences in colour because of the different materials that are used.



Tempo complete shower (top and bottom part)							
Top part design	Outside dimensions Glass design		2 transparent side walls	1 transparent + 1 white side wall	1 transparent + 1 patterned side wall, white	2 white side walls	1 patterned side wall, white + 1 side wall with motif, white
Swing door, 1 piece	800 × 800 Acrylic glass	Mat. no. TP+BP Type	1115001303 801 PS	1115001304 802 PS	1115001306 804 PS	1115001317 805 PS	1115001311 809 PS
	800 × 800 Genuine glass	Mat. no. TP+BP Type	1115001371 801 ESG	1115001372 802 ESG	1115001374 804 ESG	1115001375 805 ESG	1115001379 809 ESG
Swing door, 2 pieces	800 × 800 Acrylic glass	Mat. no. TP+BP Type	1115001313 811 PS	1115001314 812 PS	1115001316 814 PS	1115001317 815 PS	1115001321 819 PS
	800 × 800 Genuine glass	Mat. no. TP+BP Type	1115001381 811 ESG	1115001382 812 ESG	1115001384 814 ESG	1115001385 815 ESG	1115001389 819 ESG

Note: Side walls can be installed at the left or right according to choice. (All dimensions in mm)
 Tempo complete showers are only available without a boiler or pump.

*Design, Dimensions,
Technical Data*

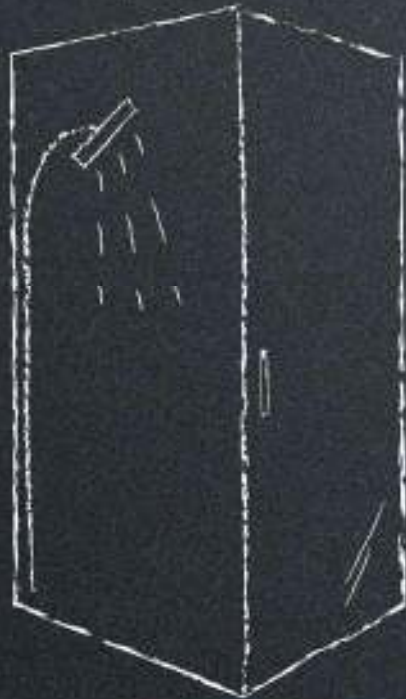

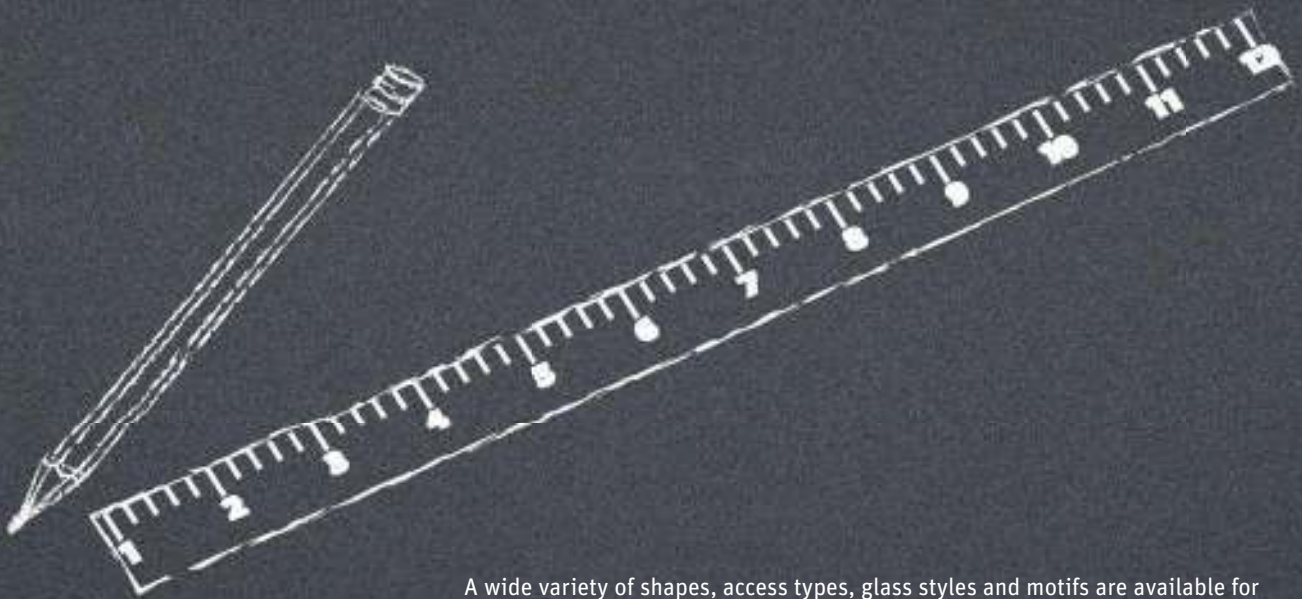

A wide variety of shapes, access types, glass styles and motifs are available for designing your customised shower. We are happy to plan a tailor-made solution for your space and provide a drawing on request.

Working closely with the specialist dealer and sanitary system installer to design a shower screen guarantees the best results for your dream bathroom. The dimensions, shape and position of the bathroom's windows, doors and fittings are taken into consideration at the planning stage.

Glass shower designs

■ Profile colours



■ silver satin*



■ white

Other colours available for all models on request.

■ Finish on fittings and handles

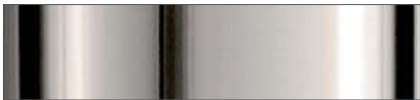

■ chrome



Glass shower designs

■ Glass patterns

Alina®, Laguna® Maxi Wave, Laguna®, Gala® P and Cariba® (only on flat glass)



■ Mastercarre



■ SR 200

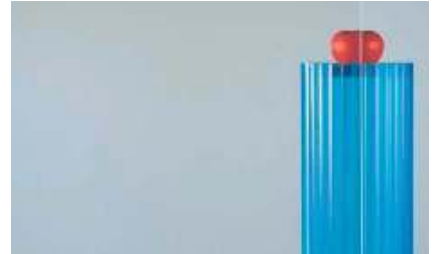

■ Genuine clear glass



■ Chinchilla



■ Matt glass (imitation acid frosting)



■ Wave motif (Laguna® Maxi Wave)



■ Mirastar

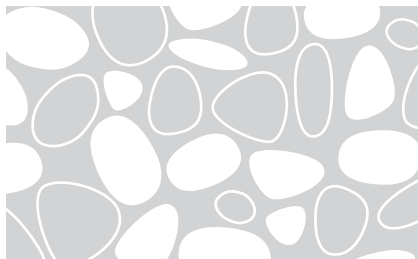

■ Stone motif



■ Pixel motif

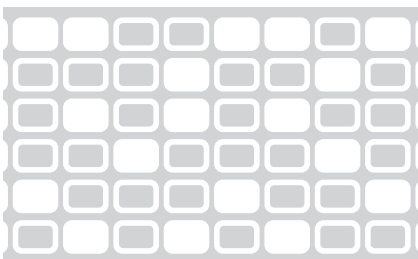

■ Retro motif





Because of the production process, the pattern may be slightly displaced on Mastercarre panes. Consequently, a seamless continuation of the pattern cannot be guaranteed on shower solutions with several panes.

There may be colour differences due to the printing technique. On thicker glass, the "greenish" effect may be more obvious.

*) Handles and decorative parts in genuine chrome.

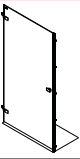
Photos of Mastercarre and SR 200: Saint-Gobain
Photos of Chinchilla and genuine clear glass: Schlatt

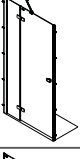
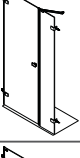
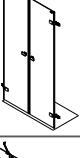
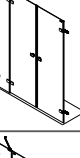
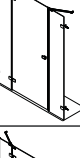
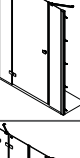
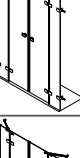
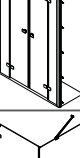
Alina® dimensions

Drawing	Material number	Model	Height [mm]	Width [mm]	Type
	1120000140	Roth Alina® glass shower P1 1-piece swing door for niche	2000	up to 1000	AP100
	1120000141	Roth Alina® glass shower P2A 1-piece swing door for niche	2000	up to 1300	AP110
	1120000142	Roth Alina® glass shower P2A 1-piece swing door for niche with profile	2000	up to 1300	AP120
	1120000143	Roth Alina® glass shower P2S 1-piece swing door for niche	2000	up to 1300	AP130
	1120000144	Roth Alina® glass shower P2 2-piece swing door for niche	2000	up to 1500	AP140
	1120000145	Roth Alina® glass shower P3A 1-piece swing door for niche	2000	up to 1800	AP150
	1120000146	Roth Alina® glass shower P3AS 1-piece swing door for niche	2000	up to 1800	AP160
	1120000147	Roth Alina® glass shower P3AS 1-piece swing door for niche with profile	2000	up to 1800	AP170
	1120000148	Roth Alina® glass shower P4A 2-piece swing door for niche	2000	up to 2400	AP180
	1120000149	Roth Alina® glass shower P4A 2-piece swing door for niche with profile	2000	up to 2400	AP190
	1120000150	Roth Alina® glass shower PS2S swing door with side wall	2000	Door up to 1000 Side wall up to 1200	AP200

Special heights and larger widths available on request.

Alina® dimensions

Drawing	Material number	Model	Height [mm]	Width [mm]	Type
	1120000151	Roth Alina® glass shower PSK2S swing door with side wall shortened next to skirting	2000	Door up to 1000 Side wall up to 1200	AP210
	1120000152	Roth Alina® glass shower PS3A swing door with side wall	2000	Door up to 1300 Side wall up to 1200	AP220
	1120000153	Roth Alina® glass shower PS3A swing door with side wall with profile	2000	Door up to 1300 Side wall up to 1200	AP230
	1120000154	Roth Alina® glass shower PSK3A swing door with side wall shortened next to skirting	2000	Door up to 1300 Side wall up to 1200	AP240
	1120000155	Roth Alina® glass shower PSK3A swing door with side wall shortened next to skirting with profile	2000	Door up to 1300 Side wall up to 1200	AP250
	1120000156	Roth Alina® glass shower PS3S swing door with side wall	2000	Door up to 1300 Side wall up to 1200	AP260
	1120000157	Roth Alina® glass shower PSK3S swing door with side wall shortened to skirting	2000	Door up to 1300 Side wall up to 1200	AP270
	1120000158	Roth Alina® glass shower PS4AS swing door with side wall	2000	Door up to 1800 Side wall up to 1200	AP280
	1120000159	Roth Alina® glass shower PS4AS swing door with side wall with profile	2000	Door up to 1800 Side wall up to 1200	AP290
	1120000160	Roth Alina® glass shower E2 corner access, 2 pieces	2000	up to 1000	AP300
	1120000161	Roth Alina® glass shower E4 corner access, 4 pieces	2000	up to 1300	AP310

Special heights and larger widths available on request.

Alina® dimensions

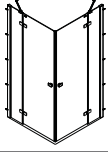
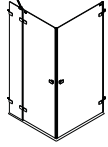
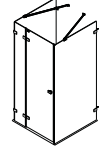
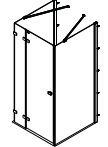
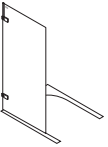
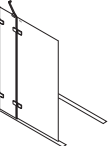
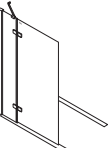
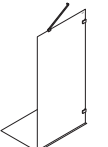
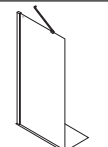
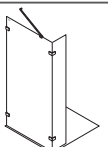
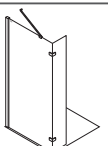
Drawing	Material number	Model	Height [mm]	Width [mm]	Type
	1120000162	Roth Alina® glass shower E4 corner access, 4 pieces with profile	2000	up to 1300	AP320
	1120000163	Roth Alina® glass shower E3 corner access, 3 pieces	2000	Door fixed element up to 1300 Door up to 1000	AP330
	1120000164	Roth Alina® glass shower PSS4A swing door with 2 side walls	2000	Door up to 1300 Side wall up to 1200	AP340
	1120000165	Roth Alina® glass shower PSS4A swing door with 2 side walls with profile	2000	Door up to 1300 Side wall up to 1200	AP350
	1120000166	Roth Alina® glass shower B1 bath tub screen, 1 piece	1500	up to 900	AP360
	1120000167	Roth Alina® glass shower B2F bath tub screen, 2 pieces	1500	up to 1400	AP370
	1120000168	Roth Alina® glass shower B2F bath tub screen, 2 pieces with profile	1500	up to 1400	AP380
	1120000169	Roth Alina® glass shower SW1 side wall, 1 piece, freestanding	2000	up to 1200	AP390
	1120000170	Roth Alina® glass shower SW1 side wall, 1 piece, freestanding with profile	2000	up to 1200	AP400
	1120000171	Roth Alina® glass shower SW2 side wall, 2 pieces, freestanding	2000	up to 1200/400	AP410
	1120000172	Roth Alina® glass shower SW2 side wall, 2 pieces, freestanding with profile	2000	up to 1200/400	AP420

Special heights and larger widths available on request.

Laguna® Maxi Wave dimensions

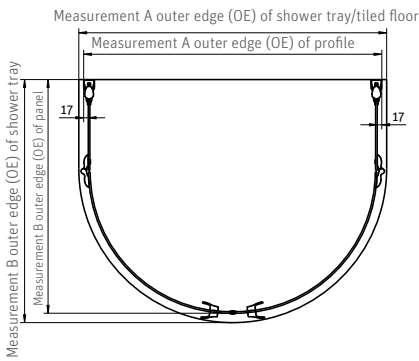

Installation on shower tray and tiled floor

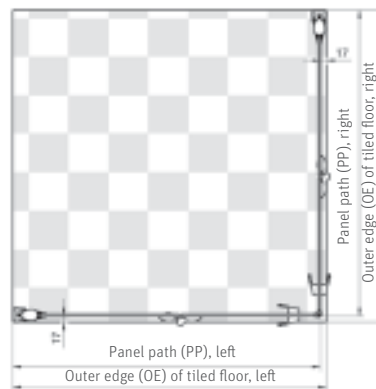
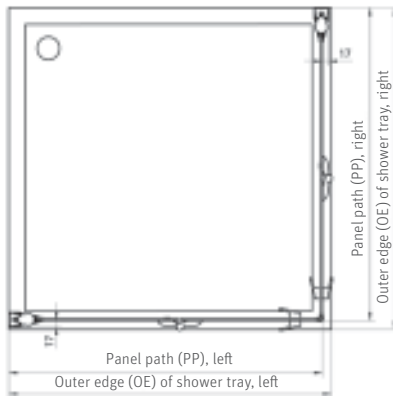

Installation on shower tray 2 doors (diagram on the left)

Shower tray OE - PP = at least 17 mm
(optimum 25 mm = standard)
Adjustment range of profile: +10/-10 mm

Installation on tiled floor 2 doors (diagram on the right)

Floor tile OE = PP + 17
Adjustment range of profile: +15/-5 mm

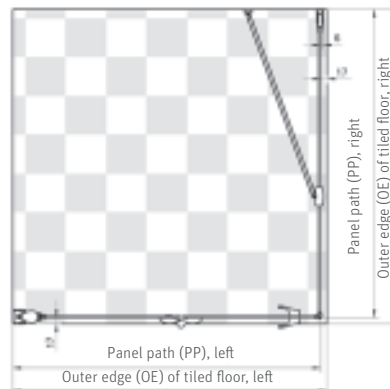
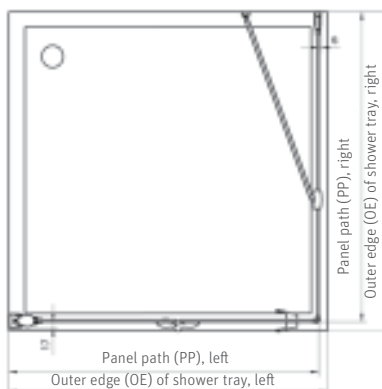

Installation on shower tray, folding door with side wall (bottom left diagram)

Shower tray OE - PP = at least 17 mm
(optimum 25 mm = standard)
Adjustment range of profile: +10/-10 mm

Installation on tiled floor, folding door with side wall (bottom right diagram)

Floor tile OE = PP + 17
Adjustment range of profile: +15/-5 mm

Laguna® Maxi Wave dimensions

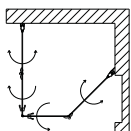
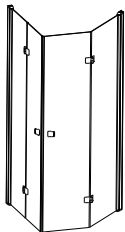
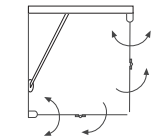
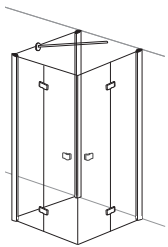
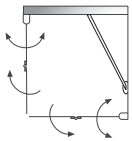
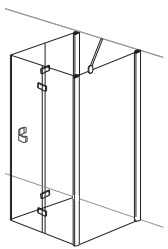
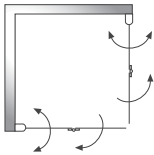
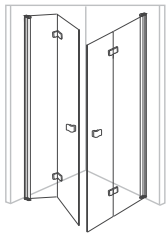

Corner access 4 pieces							LMWE4	
Mat. no.: 112000068								
Model	Height shower screen	Installation on shower tray		Installation on tiled floor		Access width approx.	Type	Individual design dimension range min. - max.
		PP left	PP right	PP left	PP right			
Laguna® Maxi Wave E4 800	2000	775	775	783	783	475 - 960	MW700	700 - 820
Laguna® Maxi Wave E4 900	2000	875	875	883	883	545 - 1100	MW702	821 - 920
Laguna® Maxi Wave E4 1000	2000	975	975	983	983	615 - 1240	MW704	921 - 1020
Laguna® Maxi Wave E4 1100	2000	1075	1075	1083	1083	685 - 1380	MW706	1021 - 1120
Laguna® Maxi Wave E4 1200	2000	1175	1175	1183	1183	755 - 1520	MW708	1121 - 1220
Laguna® Maxi Wave E4 1300	2000	1275	1275	1283	1283	825 - 1660	MW710	1221 - 1320
Laguna® Maxi Wave E4 1400	2000	1375	1375	1383	1383	895 - 1800	MW712	1321 - 1420
Laguna® Maxi Wave E4 1500	2000	1475	1475	1483	1483	965 - 1940	MW714	1421 - 1520

All dimensions in mm

Corner access, 4 pieces with additional side wall							LMWE5	
Mat. no.: 1120000110								
Model	Height shower screen	Installation on shower tray		Installation on tiled floor		Access width approx.	Type	Individual design dimension range min. - max.
		PP left	PP right	PP left	PP right			
Laguna® Maxi Wave E5 800 left	2000	775	775	783	783	475 - 960	MW930	700 - 820
Laguna® Maxi Wave E5 900 left	2000	875	875	883	883	545 - 1100	MW932	821 - 920
Laguna® Maxi Wave E5 1000 left	2000	975	975	983	983	615 - 1240	MW934	921 - 1020
Laguna® Maxi Wave E5 1100 left	2000	1075	1075	1083	1083	685 - 1380	MW936	1021 - 1120
Laguna® Maxi Wave E5 1200 left	2000	1175	1175	1183	1183	755 - 1520	MW938	1121 - 1220

All dimensions in mm

Corner access, 4 pieces with additional side wall							LMWE5	
Mat. no.: 1120000110								
Model	Height shower screen	Installation on shower tray		Installation on tiled floor		Access width approx.	Type	Individual design dimension range min. - max.
		PP left	PP right	PP left	PP right			
Laguna® Maxi Wave E5 800 right	2000	775	775	783	783	475 - 960	MW940	700 - 820
Laguna® Maxi Wave E5 900 right	2000	875	875	883	883	545 - 1100	MW942	821 - 920
Laguna® Maxi Wave E5 1000 right	2000	975	975	983	983	615 - 1240	MW944	921 - 1020
Laguna® Maxi Wave E5 1100 right	2000	1075	1075	1083	1083	685 - 1380	MW946	1021 - 1120
Laguna® Maxi Wave E5 1200 right	2000	1175	1175	1183	1183	755 - 1520	MW948	1121 - 1220

All dimensions in mm

Corner window solution, 4 pieces						LMWFE4	
Mat. no.: 1120000180							
Model	Height shower screen	Installation dimensions		Access width approx.	Type	Dimension range for individual designs min.-max.	
		left	right				
Laguna® Maxi Wave FE4 900 right	2000	900	900	560 - 900	MW 500	750 - 920	
Laguna® Maxi Wave FE4 1000 right	2000	1000	1000	670 - 1000	MW 520	921 - 1020	

All dimensions in mm

Corner window solution, 4 pieces						LMWFE4	
Mat. no.: 1180000180							
Model	Height shower screen	Installation dimensions		Access width approx.	Type	Dimension range for individual designs min. - max.	
		left	right				
Laguna® Maxi Wave FE4 900 left	2000	900	900	560 - 900	MW 504	750 - 920	
Laguna® Maxi Wave FE4 1000 left	2000	1000	1000	670 - 1000	MW 506	921 - 1020	

All dimensions in mm

Laguna® Maxi Wave dimensions

Corner access, 3 pieces LMWE3								
Mat. no.: 1120000090								
Model	Height shower screen	Installation on shower tray		Installation on tiled floor		Access width approx.	Type	Individual design dimension range min. - max.
		PP left	PP right	PP left	PP right			
Laguna® Maxi Wave E3 800 left	2000	775	775	783	783	475 - 960	MW824	700 - 820
Laguna® Maxi Wave E3 900 left	2000	875	875	883	883	545 - 1100	MW826	821 - 920
Laguna® Maxi Wave E3 1000 left	2000	975	975	983	983	615 - 1240	MW828	921 - 1020
Laguna® Maxi Wave E3 1100 left	2000	1075	1075	1083	1083	685 - 1380	MW830	1021 - 1120
Laguna® Maxi Wave E3 1200 left	2000	1175	1175	1183	1183	755 - 1520	MW832	1121 - 1220
Laguna® Maxi Wave E3 1300 left	2000	1275	1275	1283	1283	825 - 1660	MW834	1221 - 1320
Laguna® Maxi Wave E3 1400 left	2000	1375	1375	1383	1383	895 - 1800	MW836	1321 - 1420
Laguna® Maxi Wave E3 1500 left	2000	1475	1475	1483	1483	965 - 1940	MW838	1421 - 1520

All dimensions in mm

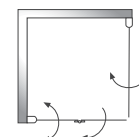
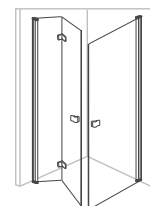

Corner access, 3 pieces LMWE3								
Mat. no.: 1120000090								
Model	Height shower screen	Installation on shower tray		Installation on tiled floor		Access width approx.	Type	Individual design dimension range min. - max.
		PP left	PP right	PP left	PP right			
Laguna® Maxi Wave E3 800 right	2000	775	775	783	783	475 - 960	MW840	700 - 820
Laguna® Maxi Wave E3 900 right	2000	875	875	883	883	545 - 1100	MW842	821 - 920
Laguna® Maxi Wave E3 1000 right	2000	975	975	983	983	615 - 1240	MW844	921 - 1020
Laguna® Maxi Wave E3 1100 right	2000	1075	1075	1083	1083	685 - 1380	MW846	1021 - 1120
Laguna® Maxi Wave E3 1200 right	2000	1175	1175	1183	1183	755 - 1520	MW848	1121 - 1220
Laguna® Maxi Wave E3 1300 right	2000	1275	1275	1283	1283	825 - 1660	MW850	1221 - 1320
Laguna® Maxi Wave E3 1400 right	2000	1375	1375	1383	1383	895 - 1800	MW852	1321 - 1420
Laguna® Maxi Wave E3 1500 right	2000	1475	1475	1483	1483	965 - 1940	MW854	1421 - 1520

All dimensions in mm

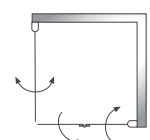
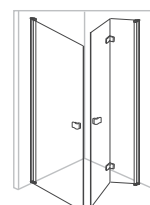

Folding door, 2 pieces with side wall LMWSS3								
Mat. no.: 1120000069								
Model	Height shower screen	Installation on shower tray		Installation on tiled floor		Access width approx.	Type	Individual design dimension range min. - max.
		PP left	PP right	PP left	PP right			
Laguna® Maxi Wave SS3 800 left	2000	775	775	783	783	335 - 675	MW716	700 - 820
Laguna® Maxi Wave SS3 900 left	2000	875	875	883	883	385 - 775	MW718	821 - 920
Laguna® Maxi Wave SS3 1000 left	2000	975	975	983	983	435 - 875	MW720	921 - 1020
Laguna® Maxi Wave SS3 1100 left	2000	1075	1075	1083	1083	485 - 975	MW722	1021 - 1120
Laguna® Maxi Wave SS3 1200 left	2000	1175	1175	1183	1183	535 - 1075	MW724	1121 - 1220
Laguna® Maxi Wave SS3 1300 left	2000	1275	1275	1283	1283	585 - 1175	MW726	1221 - 1320
Laguna® Maxi Wave SS3 1400 left	2000	1375	1375	1383	1383	635 - 1275	MW728	1321 - 1420
Laguna® Maxi Wave SS3 1500 left	2000	1475	1475	1483	1483	685 - 1375	MW730	1421 - 1520

All dimensions in mm

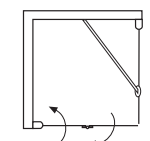
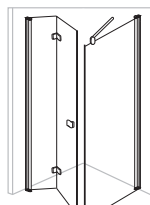

Folding door, 2 pieces with side wall LMWSS3								
Mat. no.: 1120000069								
Model	Height shower screen	Installation on shower tray		Installation on tiled floor		Access width approx.	Type	Individual design dimension range min. - max.
		PP left	PP right	PP left	PP right			
Laguna® Maxi Wave SS3 800 right	2000	775	775	783	783	335 - 675	MW732	700 - 820
Laguna® Maxi Wave SS3 900 right	2000	875	875	883	883	385 - 775	MW734	821 - 920
Laguna® Maxi Wave SS3 1000 right	2000	975	975	983	983	435 - 875	MW736	921 - 1020
Laguna® Maxi Wave SS3 1100 right	2000	1075	1075	1083	1083	485 - 975	MW738	1021 - 1120
Laguna® Maxi Wave SS3 1200 right	2000	1175	1175	1183	1183	535 - 1075	MW740	1121 - 1220
Laguna® Maxi Wave SS3 1300 right	2000	1275	1275	1283	1283	585 - 1175	MW742	1221 - 1320
Laguna® Maxi Wave SS3 1400 right	2000	1375	1375	1383	1383	635 - 1275	MW744	1321 - 1420
Laguna® Maxi Wave SS3 1500 right	2000	1475	1475	1483	1483	685 - 1375	MW746	1421 - 1520

All dimensions in mm

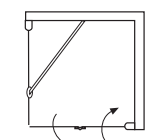
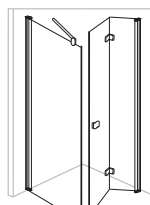

Laguna® Maxi Wave dimensions

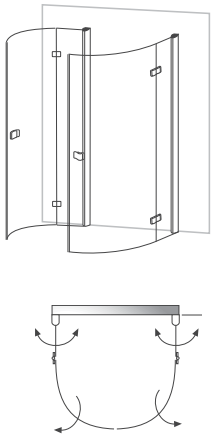

Semi-circular shower, 4 pieces LMWHK4

Mat. no.: 1120000066

Model	Height shower screen	Measurement A		Measurement B		Measurm. C	Measurm. D	Shower tray	Type	Access width approx.
		OE tray	OE profile	OE tray	OE panel					
Laguna® Maxi Wave HK4 1000 r=500	2012	1000	1000	850	833	362	256	Duscholux Circle	MW804	660 - 940
Laguna® Maxi Wave HK4 1030 r=520	2012	1030	1030	825	808	320	253	Hoesch Amalfi 1100	MW806	690 - 970
Laguna® Maxi Wave HK4 1140 r=550	2012	1140	1104	900	865	343	272	Hüppe Marano	MW808	730 - 1040
Laguna® Maxi Wave HK4 900 r=500	2012	900	900	783	766	322	219	Tiled floor	MW810	660 - 840
Laguna® Maxi Wave HK4 1000 r=500	2012	1000	1000	800	779	310	245	Tiled floor	MW812	660 - 940

All dimensions in mm

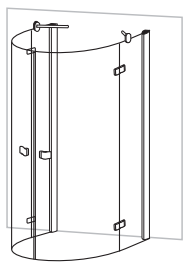
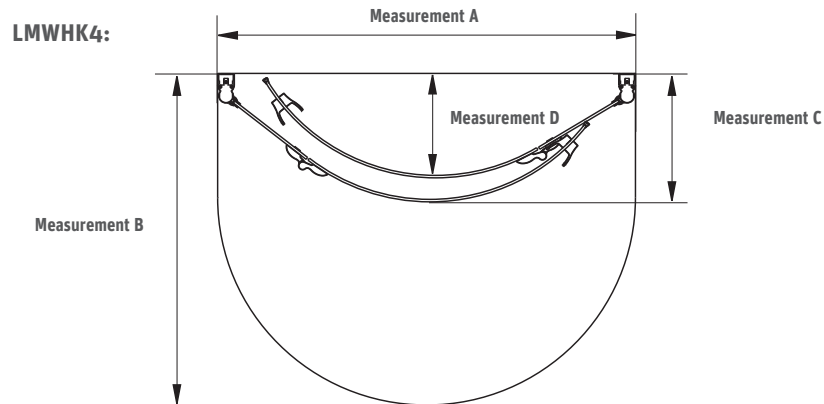

Semi-circular shower, 4 pieces with 2 fixed elements LMWHK4F

Mat. no.: 1120000067

Model	Height shower screen	Measurement A:		Measurement B		Shower tray	Type	Access width approx.
		OE tray	OE profile	OE tray	OE panel			
Laguna® Maxi Wave HK4F 900 r=500	2000	900	900	900	883	Bette Point 900	MW814	660 - 840
Laguna® Maxi Wave HK4F 1000 r=500	2000	1000	1000	1000	983	Bette Point 1000	MW816	660 - 940
Laguna® Maxi Wave HK4F 1000 r=500	2000	1000	1000	850	833	Duscholux Circle	MW818	660 - 940
Laguna® Maxi Wave HK4F 1030 r=520	2000	1030	1030	825	808	Hoesch Amalfi 1100	MW820	690 - 970
Laguna® Maxi Wave HK4F 1140 r=550	2000	1140	1103	900	865	Hüppe Marano	MW822	730 - 1040

All dimensions in mm

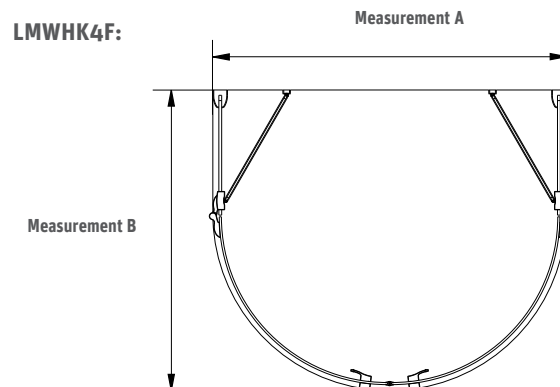

Laguna® Maxi Wave dimensions

Walk-In, freestanding, 1 piece		LMWSWF1	
Mat. no.: 1120000091			
Model	Height shower screen	Width	Type
Laguna® Maxi Wave SWF1	2000	max. 1800	MW856

All dimensions in mm

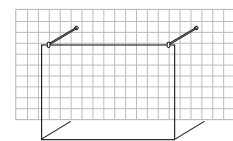

Walk-In, 1 piece		LMWSW1	
Mat. no.: 1120000092			
Model	Height shower screen	Width	Type
Laguna® Maxi Wave SW1 left	2000	max. 1500	MW858

All dimensions in mm

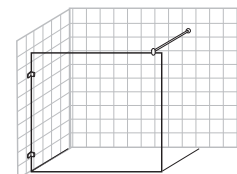

Walk-In, 1 piece		LMWSW1	
Mat. no.: 1120000092			
Model	Height shower screen	Width	Type
Laguna® Maxi Wave SW1 right	2000	max. 1500	MW860

All dimensions in mm

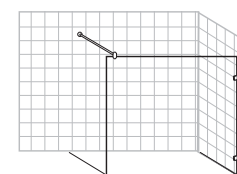

Walk-In P, 1 piece		LMWSWP1	
Mat. no.: 1120000093			
Model	Height shower screen	Width	Type
Laguna® Maxi Wave SWP1 left	2000	max. 1500	MW862

All dimensions in mm

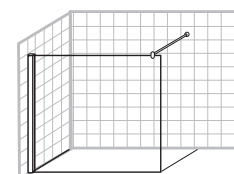

Walk-In P, 1 piece		LMWSWP1	
Mat. no.: 1120000093			
Model	Height shower screen	Width	Type
Laguna® Maxi Wave SWP1 right	2000	max. 1500	MW864

All dimensions in mm

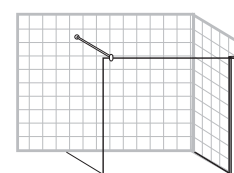

Laguna® Maxi Wave dimensions

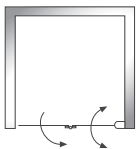
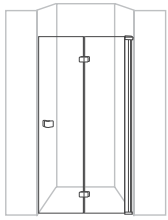

Folding door for niche, 2 pieces LMWS2

Mat. no.: 1120000070

Model	Height shower screen	Niche width		Access width approx.	Type	Individual design for niche min. - max.
		min.	max.			
Laguna® Maxi Wave S2 800 right	2000	790	810	335 - 670	MW758	700 - 820
Laguna® Maxi Wave S2 900 right	2000	890	910	385 - 770	MW760	821 - 920
Laguna® Maxi Wave S2 1000 right	2000	990	1010	435 - 870	MW762	921 - 1020
Laguna® Maxi Wave S2 1100 right	2000	1090	1110	485 - 970	MW764	1021 - 1120
Laguna® Maxi Wave S2 1200 right	2000	1190	1210	535 - 1070	MW766	1121 - 1220
Laguna® Maxi Wave S2 1300 right	2000	1290	1310	585 - 1170	MW870	1221 - 1320
Laguna® Maxi Wave S2 1400 right	2000	1390	1410	635 - 1270	MW872	1321 - 1420

All dimensions in mm

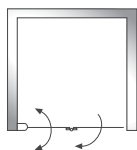
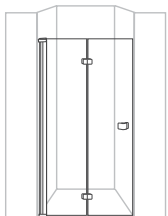

Folding door for niche, 2 pieces LMWS2

Mat. no.: 1120000070

Model	Height shower screen	Niche width		Access width approx.	Type	Individual design for niche min. - max.
		min.	max.			
Laguna® Maxi Wave S2 800 left	2000	790	810	335 - 670	MW748	700 - 820
Laguna® Maxi Wave S2 900 left	2000	890	910	385 - 770	MW750	821 - 920
Laguna® Maxi Wave S2 1000 left	2000	990	1010	435 - 870	MW752	921 - 1020
Laguna® Maxi Wave S2 1100 left	2000	1090	1110	485 - 970	MW754	1021 - 1120
Laguna® Maxi Wave S2 1200 left	2000	1190	1210	535 - 1070	MW756	1121 - 1220
Laguna® Maxi Wave S2 1300 left	2000	1290	1310	585 - 1170	MW866	1221 - 1320
Laguna® Maxi Wave S2 1400 left	2000	1390	1410	635 - 1270	MW868	1321 - 1420

All dimensions in mm

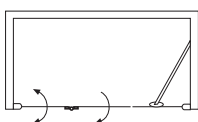
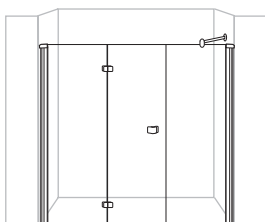

Folding door for niche, 2 pieces with side wall LMWS3F

Mat. no.: 1120000120

Model	Height shower screen	Niche width		Access width approx.	Type	Individual design for niche min. - max.
		min.	max.			
Laguna® Maxi Wave S3F 1000 left	2000	990	1010	290 - 590	MW950	900 - 1020
Laguna® Maxi Wave S3F 1100 left	2000	1090	1110	325 - 659	MW952	1021 - 1120
Laguna® Maxi Wave S3F 1200 left	2000	1190	1210	358 - 725	MW954	1121 - 1220
Laguna® Maxi Wave S3F 1300 left	2000	1290	1310	391 - 791	MW956	1221 - 1320
Laguna® Maxi Wave S3F 1400 left	2000	1390	1410	425 - 858	MW958	1321 - 1420
Laguna® Maxi Wave S3F 1500 left	2000	1490	1510	459 - 925	MW960	1421 - 1520
Laguna® Maxi Wave S3F 1600 left	2000	1590	1610	490 - 990	MW962	1521 - 1620
Laguna® Maxi Wave S3F 1700 left	2000	1690	1710	524 - 1058	MW964	1621 - 1720
Laguna® Maxi Wave S3F 1800 left	2000	1790	1810	558 - 1125	MW966	1721 - 1820
Laguna® Maxi Wave S3F 1900 left	2000	1890	1910	591 - 1191	MW968	1821 - 1920
Laguna® Maxi Wave S3F 2000 left	2000	1990	2010	625 - 1258	MW970	1921 - 2020

All dimensions in mm

Laguna® Maxi Wave dimensions

Folding door for niche, 2 pieces with side wall LMWS3F

Mat. no.: 1120000120

Model	Height shower screen	Niche width		Access width approx.	Type	Individual design for niche min. - max.
		min.	max.			
Laguna® Maxi Wave S3F 1000 right	2000	990	1010	290 - 590	MW972	900 - 1020
Laguna® Maxi Wave S3F 1100 right	2000	1090	1110	325 - 659	MW974	1021 - 1120
Laguna® Maxi Wave S3F 1200 right	2000	1190	1210	358 - 725	MW976	1121 - 1220
Laguna® Maxi Wave S3F 1300 right	2000	1290	1310	391 - 791	MW978	1221 - 1320
Laguna® Maxi Wave S3F 1400 right	2000	1390	1410	425 - 858	MW980	1321 - 1420
Laguna® Maxi Wave S3F 1500 right	2000	1490	1510	459 - 925	MW982	1421 - 1520
Laguna® Maxi Wave S3F 1600 right	2000	1590	1610	490 - 990	MW984	1521 - 1620
Laguna® Maxi Wave S3F 1700 right	2000	1690	1710	524 - 1058	MW986	1621 - 1720
Laguna® Maxi Wave S3F 1800 right	2000	1790	1810	558 - 1125	MW988	1721 - 1820
Laguna® Maxi Wave S3F 1900 right	2000	1890	1910	591 - 1191	MW990	1821 - 1920
Laguna® Maxi Wave S3F 2000 right	2000	1990	2010	625 - 1258	MW992	1921 - 2020

All dimensions in mm

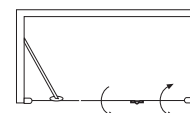
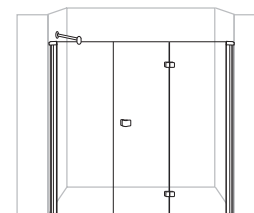

Folding door for niche, 4 pieces LMWS4

Mat. no.: 1120000071

Model	Height shower screen	Niche width		Access width approx.	Type	Individual design for niche min. - max.
		min.	max.			
Laguna® Maxi Wave S4 1500	2000	1490	1510	670 - 1340	MW776	1421 - 1520
Laguna® Maxi Wave S4 1600	2000	1590	1610	720 - 1440	MW778	1521 - 1620
Laguna® Maxi Wave S4 1700	2000	1690	1710	770 - 1540	MW780	1621 - 1720
Laguna® Maxi Wave S4 1800	2000	1790	1810	820 - 1640	MW782	1721 - 1820
Laguna® Maxi Wave S4 1900	2000	1890	1910	870 - 1740	MW784	1821 - 1920
Laguna® Maxi Wave S4 2000	2000	1990	2010	920 - 1840	MW786	1921 - 2020
Laguna® Maxi Wave S4 2100	2000	2090	2110	970 - 1940	MW788	2021 - 2120
Laguna® Maxi Wave S4 2200	2000	2190	2210	1020 - 2040	MW790	2121 - 2220
Laguna® Maxi Wave S4 2300	2000	2290	2310	1070 - 2140	MW792	2221 - 2320
Laguna® Maxi Wave S4 2400	2000	2390	2410	1120 - 2240	MW794	2321 - 2420
Laguna® Maxi Wave S4 2500	2000	2490	2510	1170 - 2340	MW796	2421 - 2520

All dimensions in mm

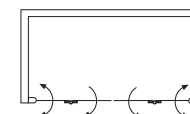
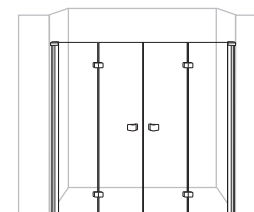

Partition, 2 pieces LMWT2

Mat. no.: 1120000100

Model	Height shower screen	Niche width		Access width approx.	Type	Individual design for niche min. - max.
		min.	max.			
Laguna® Maxi Wave T2 800 left	2000	790	810	335 - 670	MW902	750 - 820
Laguna® Maxi Wave T2 900 left	2000	890	910	385 - 770	MW904	821 - 920
Laguna® Maxi Wave T2 1000 left	2000	990	1010	435 - 870	MW906	921 - 1020
Laguna® Maxi Wave T2 1100 left	2000	1090	1110	485 - 970	MW908	1021 - 1120
Laguna® Maxi Wave T2 1200 left	2000	1190	1210	535 - 1070	MW910	1121 - 1220
Laguna® Maxi Wave T2 1300 left	2000	1290	1310	585 - 1170	MW912	1221 - 1320
Laguna® Maxi Wave T2 1400 left	2000	1390	1410	635 - 1270	MW914	1321 - 1420

All dimensions in mm

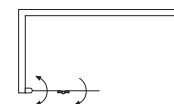
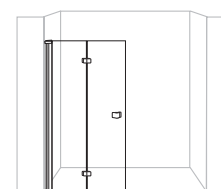

Partition, 2 pieces LMWT2

Mat. no.: 1120000100

Model	Height shower screen	Niche width		Access width approx.	Type	Individual design for niche min. - max.
		min.	max.			
Laguna® Maxi Wave T2 800 right	2000	790	810	335 - 670	MW916	750 - 820
Laguna® Maxi Wave T2 900 right	2000	890	910	385 - 770	MW918	821 - 920
Laguna® Maxi Wave T2 1000 right	2000	990	1010	435 - 870	MW920	921 - 1020
Laguna® Maxi Wave T2 1100 right	2000	1090	1110	485 - 970	MW922	1021 - 1120
Laguna® Maxi Wave T2 1200 right	2000	1190	1210	535 - 1070	MW924	1121 - 1220
Laguna® Maxi Wave T2 1300 right	2000	1290	1310	585 - 1170	MW926	1221 - 1320
Laguna® Maxi Wave T2 1400 right	2000	1390	1410	635 - 1270	MW928	1321 - 1420

All dimensions in mm

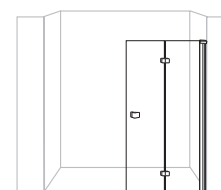

Laguna® Maxi Wave dimensions

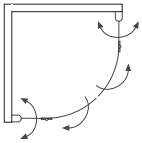
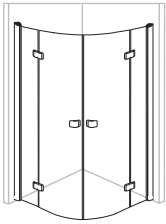

Round shower, 4 pieces LMWR4								
Mat. no.: 1120000111								
Model	Height shower screen	Installation on shower tray		Installation on tiled floor		Access width approx.	Type	Individual design dimension range min. - max.
		PP left	PP right	PP left	PP right			
Laguna® Maxi Wave R4 800 r=500	2000	775	775	783	783	870 - 980	MW202	780 - 820
Laguna® Maxi Wave R4 800 r=550	2000	775	775	783	783	870 - 980	MW204	780 - 820
Laguna® Maxi Wave R4 900 r=500	2000	875	875	883	883	870 - 1120	MW206	821 - 920
Laguna® Maxi Wave R4 900 r=550	2000	875	875	883	883	870 - 1120	MW208	821 - 920
Laguna® Maxi Wave R4 1000 r=500	2000	975	975	983	983	870 - 1260	MW210	921 - 1020
Laguna® Maxi Wave R4 1000 r=550	2000	975	975	983	983	870 - 1260	MW212	921 - 1020
Laguna® Maxi Wave R4 1100 r=500	2000	1075	1075	1083	1083	870 - 1400	MW214	1021 - 1120
Laguna® Maxi Wave R4 1100 r=550	2000	1075	1075	1083	1083	870 - 1400	MW216	1021 - 1120
Laguna® Maxi Wave R4 1200 r=500	2000	1175	1175	1183	1183	870 - 1540	MW218	1121 - 1220
Laguna® Maxi Wave R4 1200 r=550	2000	1175	1175	1183	1183	870 - 1540	MW220	1121 - 1220

All dimensions in mm

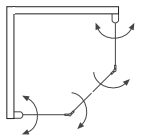
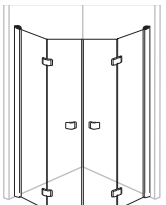

Pentagonal shower, 4 pieces LMWF4								
Mat. no.: 1120000112								
Model	Height shower screen	Installation on shower tray		Installation on tiled floor		Access width approx.	Type	Individual design dimension range min. - max.
		PP left	PP right	PP left	PP right			
Laguna® Maxi Wave F4 700	2000	675	675	683	683	505	MW302	680 - 720
Laguna® Maxi Wave F4 800	2000	775	775	783	783	590	MW304	721 - 820
Laguna® Maxi Wave F4 900	2000	875	875	883	883	590	MW306	821 - 920
Laguna® Maxi Wave F4 1000	2000	975	975	983	983	660	MW308	921 - 1020

All dimensions in mm

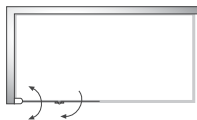
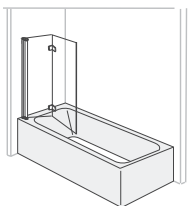

Bath tub screen, 2 pieces LMWB2			
Mat. no.: 1120000073			
Model	Height shower screen	Width	Type
Laguna® Maxi Wave B2 left	1500	max. 1400	MW800

All dimensions in mm

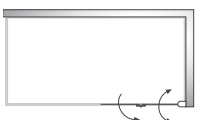
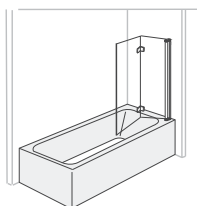

Bath tub screen, 2 pieces LMWB2			
Mat. no.: 1120000073			
Model	Height shower screen	Width	Type
Laguna® Maxi Wave B2 right	1500	max. 1400	MW802

All dimensions in mm

Laguna® dimensions

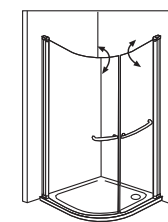
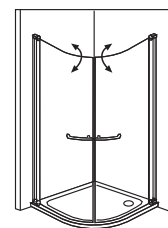

Symmetrical round shower LR2				
Mat. no.: 1120000025				
Model	Height shower screen	Tray installation dimensions min. - max.	Access width approx.	Type
Laguna® R2 800 r = 480 mm (500 mm)	1850	780 - 805	950	800
Laguna® R2 900 r = 480 mm (500 mm)	1850	880 - 905	1100	802
Laguna® R2 900 r = 530 mm (550 mm)	1850	880 - 905	1100	803

All dimensions in mm

Asymmetrical round shower LRA2					
Mat. no.: 1120000026					
Model	Height shower screen	Tray installation dimensions min. - max.	Access width approx.		Type
			small door	large door	
Laguna® RA2 900 r = 480 mm (500 mm)	1850	880 - 905	480	810	810
Laguna® RA2 900 r = 530 mm (550 mm)	1850	880 - 905	480	810	811
Laguna® RA2 900 r = 530 mm (550 mm)	2000	880 - 905	480	810	898
Laguna® RA2 1000 r = 480 mm (500 mm)	1850	980 - 1005	580	900	812
Laguna® RA2 1000 r = 530 mm (550 mm)	1850	980 - 1005	580	900	813

All dimensions in mm

Asymmetrical round shower with side wall LRA3					
Mat. no.: 1120000027					
Model	Height shower screen (with clamp)	Tray installation dimensions min. - max.	Access width approx.		Type
			small door	large door	
Laguna® RA3 900 left	1850 (2116)	880 - 905	480	810	960
Laguna® RA3 1000 left	1850 (2116)	980 - 1005	580	900	962

All dimensions in mm

Asymmetrical round shower with side wall LRA3					
Mat. no.: 1120000027					
Model	Height shower screen (with clamp)	Tray installation dimensions min. - max.	Access width approx.		Type
			small door	large door	
Laguna® RA3 900 right	1850 (2116)	880 - 905	480	810	954
Laguna® RA3 1000 right	1850 (2116)	980 - 1005	580	900	955

All dimensions in mm

Laguna® dimensions

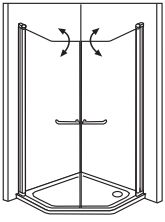

Symmetrical pentagonal shower LF2

Mat. no.: 1120000028

Model	Height shower screen	Tray installation dimensions min. - max.	Access width approx.	Type
Laguna® F2 900	1850	880 - 905	1100	820

All dimensions in mm

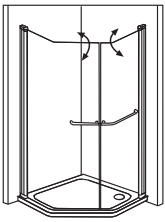

Asymmetrical pentagonal shower LFA2

Mat. no.: 1120000029

Model	Height shower screen	Tray installation dimensions min. - max.	Access width approx.		Type
			small door	large door	
Laguna® FA2 900	1850	880 - 905	440	770	825
Laguna® FA2 1000	1850	980 - 1005	480	890	826

All dimensions in mm



Asymmetrical pentagonal shower with side wall LFA3

Mat. no.: 1120000030

Model	Height shower screen (with clamp)	Tray installation dimensions min. - max.	Access width approx.		Type
			small door	large door	
Laguna® FA3 900 left	1850 (2116)	880 - 905	440	770	964
Laguna® FA3 1000 left	1850 (2116)	980 - 1005	480	890	966

All dimensions in mm



Asymmetrical pentagonal shower with side wall LFA3

Mat. no.: 1120000030

Model	Height shower screen (with clamp)	Tray installation dimensions min. - max.	Access width approx.		Type
			small door	large door	
Laguna® FA3 900 right	1850 (2116)	880 - 905	440	770	956
Laguna® FA3 1000 right	1850 (2116)	980 - 1005	480	890	957

All dimensions in mm

Laguna® dimensions

Corner access LE2					
Mat. no.: 1120000031					
Model	Height shower screen	Tray installation dimensions		Access width approx.	Type
Measurement named first is left		left min. - max.	right min. - max.		
Laguna® E2 800 × 800	1850	780 - 805	780 - 805	645 - 960	902
Laguna® E2 750 × 900	1850	730 - 755	880 - 905	595 - 915	900
Laguna® E2 900 × 750	1850	880 - 905	730 - 755	745 - 915	901
Laguna® E2 900 × 900	1850	880 - 905	880 - 905	745 - 1100	903
Laguna® E2 1000 × 1000	1850	980 - 1005	980 - 1005	845 - 1240	904

All dimensions in mm

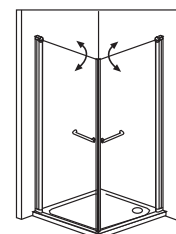

Swing door with side wall LSS2					
Mat. no.: 1120000032					
Model	Height shower screen	Tray installation dimensions		Access width approx.	Type
Measurement named first is left		left min. - max.	right min. - max.		
Laguna® SS2 800 × 800 left	1850	780 - 800	770 - 800	680 - 700	912
Laguna® SS2 750 × 900 left	1850	730 - 750	870 - 900	630 - 650	910
Laguna® SS2 900 × 750 left	1850	880 - 900	720 - 750	780 - 800	911
Laguna® SS2 900 × 900 left	1850	880 - 900	870 - 900	780 - 800	913
Laguna® SS2 1000 × 1000 left	1850	980 - 1000	970 - 1000	880 - 900	918

All dimensions in mm

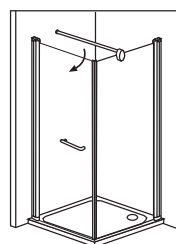

Swing door with side wall LSS2					
Mat. no.: 1120000032					
Model	Height shower screen	Tray installation dimensions		Access width approx.	Type
Measurement named first is left		left min. - max.	right min. - max.		
Laguna® SS2 800 × 800 right	1850	770 - 800	680 - 700	680 - 700	916
Laguna® SS2 750 × 900 right	1850	720 - 750	880 - 900	780 - 800	914
Laguna® SS2 900 × 750 right	1850	870 - 900	730 - 750	630 - 650	915
Laguna® SS2 900 × 900 right	1850	870 - 900	880 - 900	780 - 800	917
Laguna® SS2 1000 × 1000 right	1850	970 - 1000	980 - 1000	880 - 900	919

All dimensions in mm

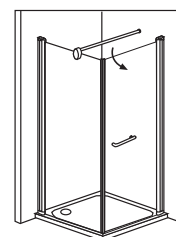

Swing door with side wall LPS3					
Mat. no.: 1120000033					
Model	Height shower screen	Tray installation dimensions		Access width approx.	Type
Measurement named first is left		left min. - max.	right min. - max.		
Laguna® PS3 800 × 800 left	1850	780 - 800	770 - 800	607 - 627	925
Laguna® PS3 750 × 900 left	1850	730 - 750	870 - 900	557 - 577	924
Laguna® PS3 900 × 750 left	1850	880 - 900	720 - 750	707 - 727	926
Laguna® PS3 900 × 900 left	1850	880 - 900	870 - 900	707 - 727	927
Laguna® PS3 1000 × 1000 left	1850	980 - 1000	970 - 1000	807 - 827	928

All dimensions in mm

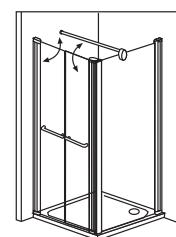

Swing door with side wall LPS3					
Mat. no.: 1120000033					
Model	Height shower screen	Tray installation dimensions		Access width approx.	Type
Measurement named first is left		left min. - max.	right min. - max.		
Laguna® PS3 800 × 800 right	1850	770 - 800	780 - 800	607 - 627	922
Laguna® PS3 750 × 900 right	1850	720 - 750	880 - 900	707 - 727	920
Laguna® PS3 900 × 750 right	1850	870 - 900	730 - 750	557 - 577	921
Laguna® PS3 900 × 900 right	1850	870 - 900	880 - 900	707 - 727	923
Laguna® PS3 1000 × 1000 right	1850	970 - 1000	980 - 1000	807 - 827	929

All dimensions in mm

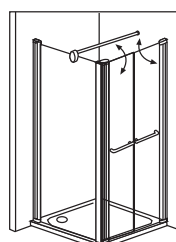

Laguna® dimensions



Swing door with 2 side walls LPS4

Mat. no.: 1120000034

Model	Height shower screen (with clamp)	Tray installation dimensions		Access width approx.	Type
		left min. - max.	right min. - max.		
First measurement is the door measurement					
Laguna® PS4 800 × 800 × 800	1850 (2116)	780 - 800	770 - 800	607 - 627	952
Laguna® PS4 750 × 900 (l.) × 900 (r.)	1850 (2116)	730 - 750	870 - 900	557 - 577	950
Laguna® PS4 900 × 750 (l.) × 750 (r.)	1850 (2116)	880 - 900	720 - 750	707 - 727	951
Laguna® PS4 900 × 900 (l.) × 900 (r.)	1850 (2116)	880 - 900	870 - 900	707 - 727	953
Laguna® PS4 1000 × 1000 (l.) × 1000 (r.)	1850 (2116)	980 - 1000	970 - 1000	807 - 827	958

All dimensions in mm

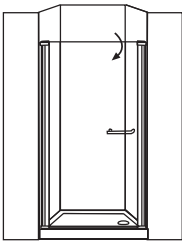

Swing door for niche LS1

Mat. no.: 1120000035

Model	Height shower screen	Niche width min. - max.	Access width approx.	Type
Laguna® S1 750	1850	734 - 766	592 - 624	930
Laguna® S1 800	1850	784 - 816	642 - 674	932
Laguna® S1 900	1850	884 - 916	742 - 774	933
Laguna® S1 1000	1850	984 - 1016	842 - 874	934

All dimensions in mm

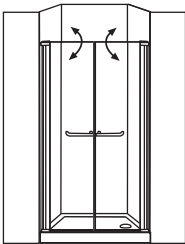

Swing door for niche LP2

Mat. no.: 1120000036

Model	Height shower screen	Niche width min. - max.	Access width approx.	Type
Laguna® P2 750	1850	730 - 770	600	830
Laguna® P2 800	1850	780 - 820	650	831
Laguna® P2 900	1850	880 - 920	750	832
Laguna® P2 1000	1850	980 - 1020	850	833

All dimensions in mm

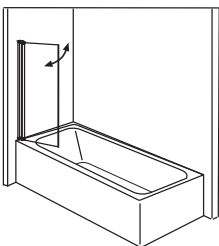

Bath tub screen LB1

Mat. no.: 1120000037

Model	Height shower screen	Width	Type
Laguna® B1 left	1500	max. 1000	967

All dimensions in mm

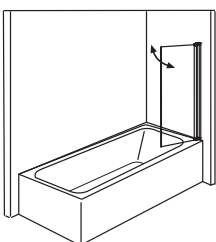

Bath tub screen LB1

Mat. no.: 1120000037

Model	Height shower screen	Width	Type
Laguna® B1 right	1500	max. 1000	968

All dimensions in mm

Gala® P Dimensions

Round shower with 2-piece swing door			GPR4	
Mat. no.: 1120000016				
Model	Height shower screen	Tray installation dimensions min. - max.	Access width approx.	Type
Gala® P R4 800 r = 500	1905	790 - 805	480 - 850	P724
Gala® P R4 800 r = 520 - 530	1905	790 - 805	480 - 850	P725
Gala® P R4 800 r = 550	1905	790 - 805	480 - 850	P726
Gala® P R4 900 r = 500	1905	890 - 905	480 - 850	P728
Gala® P R4 900 r = 520 - 530	1905	890 - 905	480 - 850	P729
Gala® P R4 900 r = 550	1905	890 - 905	480 - 850	P730
Gala® P R4 1000 r = 500	1905	990 - 1005	480 - 850	P732
Gala® P R4 1000 r = 520 - 530	1905	990 - 1005	480 - 850	P733
Gala® P R4 1000 r = 550	1905	990 - 1005	480 - 850	P734

All dimensions in mm

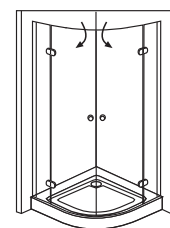

Pentagonal shower with 2-piece swing door			GPF4	
Mat. no.: 1120000017				
Model	Height shower screen	Tray installation dimensions min. - max.	Access width approx.	Type
Gala® P F4 900	1905	890 - 905	440 - 850	P744
Gala® P F4 1000	1905	990 - 1005	520 - 850	P746

All dimensions in mm

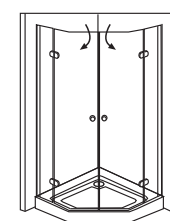

Corner access			GPE4		
Mat. no.: 1120000018					
Model	Height shower screen	Tray installation dimensions		Access width approx.	Type
		left min. - max.	right min. - max.		
Measurement named first is left					
Gala® P E4 800 × 800	1905	790 - 805	790 - 805	510 - 710	P748
Gala® P E4 750 × 900	1905	740 - 755	890 - 905	450 - 850	P750
Gala® P E4 900 × 750	1905	890 - 905	740 - 755	450 - 850	P752
Gala® P E4 900 × 900	1905	890 - 905	890 - 905	600 - 850	P754
Gala® P E4 1000 × 1000	1905	990 - 1005	990 - 1005	700 - 990	P756

All dimensions in mm

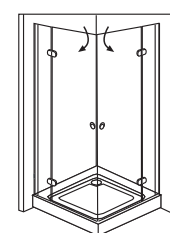

Swing door with side wall			GPSS3A		
Mat. no.: 1120000019					
Model	Height shower screen	Tray installation dimensions		Access width approx.	Type
		left min. - max.	right min. - max.		
Measurement named first is left					
Gala® P SS3A 800 left	1905	790 - 805	790 - 805	500	P758
Gala® P SS3A 750 × 900 left	1905	740 - 755	890 - 905	450	P762
Gala® P SS3A 900 × 750 left	1905	890 - 905	740 - 755	600	P766
Gala® P SS3A 900 left	1905	890 - 905	890 - 905	600	P770
Gala® P SS3A 1000 left	1905	990 - 1005	990 - 1005	700	P774

All dimensions in mm

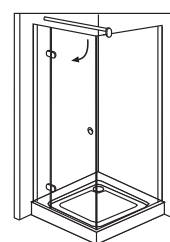

Swing door with side wall			GPSS3A		
Mat. no.: 1120000019					
Model	Height shower screen	Tray installation dimensions		Access width approx.	Type
		left min. - max.	right min. - max.		
Measurement named first is left					
Gala® P SS3A 800 right	1905	790 - 805	790 - 805	500	P760
Gala® P SS3A 750 × 900 right	1905	740 - 755	890 - 905	600	P764
Gala® P SS3A 900 × 750 right	1905	890 - 905	740 - 755	450	P768
Gala® P SS3A 900 right	1905	890 - 905	890 - 905	600	P772
Gala® P SS3A 1000 right	1905	990 - 1005	990 - 1005	700	P776

All dimensions in mm

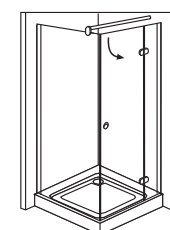

Gala® P dimensions

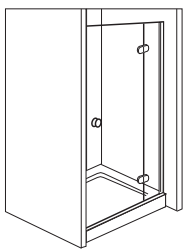

Swing door for niche		GPS2A		
Mat. no.: 1120000130				
Model	Height shower screen	Niche width min. - max.	Access width approx.	Type
Gala® P S2A 800 left	1905	780 - 810	450	P780
Gala® P S2A 900 left	1905	880 - 910	550	P782
Gala® P S2A 1000 left	1905	980 - 1010	550	P784

All dimensions in mm

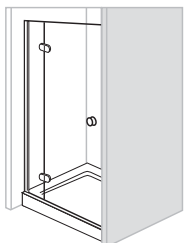

Swing door for niche		GPS2A		
Mat. no.: 1120000130				
Model	Height shower screen	Niche width min. - max.	Access width approx.	Type
Gala® P S2A 800 right	1905	780 - 810	450	P786
Gala® P S2A 900 right	1905	880 - 910	550	P788
Gala® P S2A 1000 right	1905	980 - 1010	550	P790

All dimensions in mm

Cariba® dimensions

Swing door, 1 piece CP1 NEW					
Mat. no.	Model	Height	Niche width	Access width approx.	Type
1115009232	Cariba® swing door, 1 piece without fixed element 700	2000	660 - 710	540	CP170
1115009234	Cariba® swing door, 1 piece without fixed element 750	2000	710 - 760	590	CP175
1115009236	Cariba® swing door, 1 piece without fixed element 800	2000	760 - 810	640	CP180
1115009238	Cariba® swing door, 1 piece without fixed element 900	2000	860 - 910	740	CP190
1115009240	Cariba® swing door, 1 piece without fixed element 1000	2000	960 - 1010	840	CP1100
1115009242	Cariba® swing door, 1 piece without fixed elem., indiv. dim.	up to 2000	up to 1050		CP1SONDER

All dimensions in mm

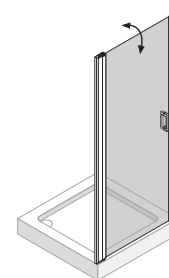

For installation in a **niche** or as a **corner solution** with side wall **SW1Aa** on the hinged side

Swing door, 1 piece with fixed element CP2A NEW					
Mat. no.	Model	Height	Niche width	Access width approx.	Type
1115009244	Cariba® swing door, 1 piece with fixed element 800	2000	760 - 810	480	CP2A80
1115009246	Cariba® swing door, 1 piece with fixed element 900	2000	860 - 910	580	CP2A90
1115009248	Cariba® swing door, 1 piece with fixed element 1000	2000	960 - 1010	680	CP2A100
1115009250	Cariba® swing door, 1 piece with fixed element 1100	2000	1060 - 1110	680	CP2A110
1115009252	Cariba® swing door, 1 piece with fixed element 1200	2000	1160 - 1210	780	CP2A120
1115009254	Cariba® swing door, 1 piece with fixed element 1300	2000	1260 - 1310	780	CP2A130
1115009256	Cariba® swing door, 1 piece with fixed elem., indiv. dim.	up to 2000	up to 1350		CP2ASONDER

All dimensions in mm

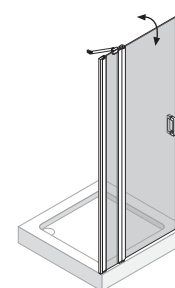

For installation in a **niche** or as a **corner solution** with side wall **SW1A** on the hinged side

Fixed element on the closure side CF1 NEW				
Mat. no.	Model	Height	Width	Type
1115009396	Cariba® fixed element on the closure side 150	2000	150	CF115
1115009398	Cariba® fixed element on the closure side 200	2000	200	CF120
1115009400	Cariba® fixed element on the closure side 250	2000	250	CF125
1115009402	Cariba® fixed element on the closure side 300	2000	300	CF130
1115009404	Cariba® fixed element on the closure side 350	2000	350	CF135
1115009406	Cariba® fixed element on the closure side 400	2000	400	CF140
1115009408	Cariba® fixed element on the closure side 450	2000	450	CF145
1115009410	Cariba® fixed elem. on the closure side, indiv. dim.	up to 2000	up to 550	CF1SONDER

All dimensions in mm

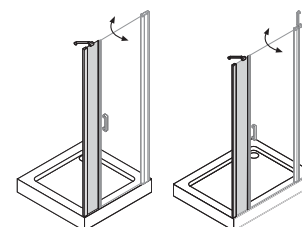

To combine with niche doors **CP1** and **CP2A** on the closure side

Side wall on the hinged side SW1A NEW				
Mat. no.	Model	Height	Tray installation dimensions	Type
1115009368	Cariba® side wall on the hinged side 700	2000	680 - 705	CSW1A70
1115009370	Cariba® side wall on the hinged side 750	2000	730 - 755	CSW1A7
1115009372	Cariba® side wall on the hinged side 800	2000	780 - 805	CSW1A80
1115009374	Cariba® side wall on the hinged side 900	2000	880 - 905	CSW1A90
1115009376	Cariba® side wall on the hinged side 1000	2000	980 - 1005	CSW1A100
1115009378	Cariba® side wall on the hinged side 1200	2000	1180 - 1205	CSW1A120
1115009380	Cariba® side wall on the hinged side, indiv. dim.	up to 2000	up to 1250	CSW1ASONDER
1115009394	Cariba® bath tub side wall, individual dimensions	up to 2000	up to 1250	CSW1ASSONDER

All dimensions in mm

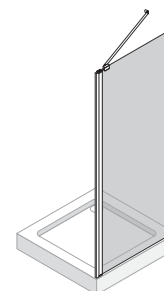

Profile outer edge to be set back by 15 mm
Glass outer edge to be set back by 22 mm

Can only be combined with all niche doors and as an additional side wall for corner, round and pentagonal solutions (U-shaped cabins).

Cariba® dimensions

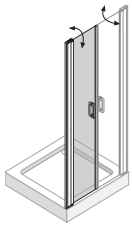

(Diagram shows 2 swing door leaves)
For installation in a **niche** or as a **corner solution** with side wall **SW1A** on the hinged side



Can also be combined with swing door leaf CP4A. An asymmetrical door arrangement can also be created by combining swing door leaves with different widths.

Swing door leaf without fixed element CP2 NEW

Mat. no.	Model	Height	Niche width	Access width approx.	Type
1115009258	Cariba® swing door leaf without fixed element 350	2000	330 - 355	250	CP235
1115009260	Cariba® swing door leaf without fixed element 400	2000	380 - 405	300	CP240
1115009262	Cariba® swing door leaf without fixed element 450	2000	430 - 455	350	CP245
1115009264	Cariba® swing door leaf without fixed element 500	2000	480 - 505	400	CP250
1115009266	Cariba® swing door leaf without fixed element 550	2000	530 - 555	450	CP255
1115009268	Cariba® swing door leaf without fixed element 600	2000	580 - 605	500	CP260
1115009270	Cariba® swing door leaf without fixed element 650	2000	630 - 655	550	CP265
1115009272	Cariba® swing door leaf without fixed element 700	2000	680 - 705	600	CP270
1115009274	Cariba® swing door leaf without fixed elem., indiv. dim.	up to 2000	up to 750		CP2SONDER

All dimensions in mm

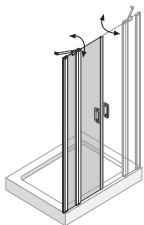

(Diagram shows 2 swing door leaves)
For installation in a **niche** or as a **corner solution** with side wall **SW1A** on the hinged side

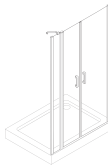

Can also be combined with swing door leaf CP2. An asymmetrical door arrangement can also be created by combining swing door leaves with different widths.

Swing door leaf with fixed element CP4A NEW

Mat. no.	Model	Height	Niche width	Access width approx.	Type
1115009276	Cariba® swing door leaf with fixed element 600	2000	580 - 605	340	CP4A60
1115009278	Cariba® swing door leaf with fixed element 650	2000	630 - 655	340	CP4A65
1115009280	Cariba® swing door leaf with fixed element 700	2000	680 - 705	390	CP4A70
1115009282	Cariba® swing door leaf with fixed element 750	2000	730 - 755	440	CP4A75
1115009284	Cariba® swing door leaf with fixed element 800	2000	780 - 805	440	CP4A80
1115009286	Cariba® swing door leaf with fixed element, indiv. dim.	up to 2000	up to 850		CP4ASONDER

All dimensions in mm

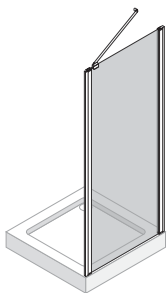

Profile outer edge to be set back by 15 mm
Glass outer edge to be set back by 22 mm

Side wall on the hinged side SW1A NEW

Mat. no.	Model	Height	Width	Type
1115009368	Cariba® side wall on the hinged side 700	2000	680 - 705	CSW1A70
1115009370	Cariba® side wall on the hinged side 750	2000	730 - 755	CSW1A75
1115009372	Cariba® side wall on the hinged side 800	2000	780 - 805	CSW1A80
1115009374	Cariba® side wall on the hinged side 900	2000	880 - 905	CSW1A90
1115009376	Cariba® side wall on the hinged side 1000	2000	980 - 1005	CSW1A100
1115009378	Cariba® side wall on the hinged side 1200	2000	1180 - 1205	CSW1A120
1115009380	Cariba® side wall on the hinged side, indiv. dim.	up to 2000	up to 1250	CSW1ASONDER
1115009394	Cariba® bath tub side wall, individual dimensions	up to 2000	up to 1250	CSW1ASONDER

All dimensions in mm

Can only be combined with all niche doors and as an additional side wall for corner, round and pentagonal solutions (U-shaped cabins).

Cariba® dimensions

Corner door leaf without fixed element CE2 NEW					
Mat. no.	Model	Height	Tray installation dimensions	Access width approx.	Type
1115009288	Cariba® corner door leaf without fixed element 700	2000	680 - 705	585	CE270
1115009290	Cariba® corner door leaf without fixed element 750	2000	730 - 755	635	CE275
1115009292	Cariba® corner door leaf without fixed element 800	2000	780 - 805	685	CE280
1115009294	Cariba® corner door leaf without fixed element 900	2000	880 - 905	785	CE290
1115009296	Cariba® corner door leaf without fixed element 1000	2000	980 - 1005	885	CE2100
1115009298	Cariba® corner door leaf without fixed elem., indiv. dim. up to 2000		up to 1050		CE2SONDER

All dimensions in mm

(Diagram shows 2 corner door leaves)
Profile outer edge to be set back by 15 mm
Glass outer edge to be set back by 22 mm

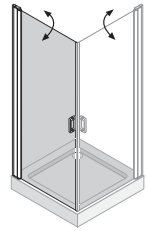

Can also be combined with corner door leaf CE4, side wall SW15 on the closure side and side wall SW1A on the hinged side (U-shaped cabin).



Corner door leaf with fixed element CE4 NEW					
Mat. no.	Model	Height	Tray installation dimensions	Access width approx.	Type
1115009300	Cariba® corner door leaf with fixed element 750	2000	730 - 755	465	CE475
1115009302	Cariba® corner door leaf with fixed element 800	2000	780 - 805	515	CE480
1115009304	Cariba® corner door leaf with fixed element 900	2000	880 - 905	615	CE490
1115009306	Cariba® corner door leaf with fixed element 1000	2000	980 - 1005	615	CE4100
1115009308	Cariba® corner door leaf with fixed element 1100	2000	1080 - 1105	715	CE4110
1115009310	Cariba® corner door leaf with fixed element 1200	2000	1180 - 1205	715	CE4120
1115009312	Cariba® corner door leaf with fixed element, indiv. dim. up to 2000		up to 1250		CE4SONDER

All dimensions in mm

(Diagram shows 2 corner door leaves)
Profile outer edge to be set back by 15 mm
Glass outer edge to be set back by 22 mm

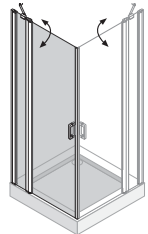

Can also be combined with corner door leaf CE2, side wall SW15 on the closure side and side wall SW1A on the hinged side (U-shaped cabin).



Side wall on the closure side SW15 NEW				
Mat. no.	Model	Height	Width	Type
1115009382	Cariba® side wall on the closure side 700	2000	680 - 705	CSW1570
1115009384	Cariba® side wall on the closure side 750	2000	730 - 755	CSW1575
1115009386	Cariba® side wall on the closure side 800	2000	780 - 805	CSW1580
1115009388	Cariba® side wall on the closure side 900	2000	880 - 905	CSW1590
1115009390	Cariba® side wall on the closure side 1000	2000	980 - 1005	CSW15100
1115009392	Cariba® side wall on the closure side, indiv. dim. up to 2000		up to 1050	CSW15SONDER

All dimensions in mm

To combine with corner door leaves CE2 and CE4
Profile outer edge to be set back by 15 mm
Glass outer edge to be set back by 22 mm

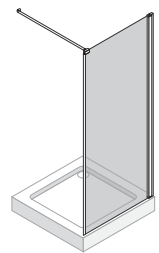

Side wall on the hinged side SW1A NEW				
Mat. no.	Model	Height	Width	Type
1115009368	Cariba® side wall on the hinged side 700	2000	680 - 705	CSW1A70
1115009370	Cariba® side wall on the hinged side 750	2000	730 - 755	CSW1A75
1115009372	Cariba® side wall on the hinged side 800	2000	780 - 805	CSW1A80
1115009374	Cariba® side wall on the hinged side 900	2000	880 - 905	CSW1A90
1115009376	Cariba® side wall on the hinged side 1000	2000	980 - 1005	CSW1A100
1115009378	Cariba® side wall on the hinged side 1200	2000	1180 - 1205	CSW1A120
1115009380	Cariba® side wall on the hinged side, indiv. dim. up to 2000		up to 1250	CSW1ASONDER
1115009394	Cariba® bath tub side wall, individual dimensions up to 2000		up to 1250	CSW1ASSONDER

All dimensions in mm

Profile outer edge to be set back by 15 mm
Glass outer edge to be set back by 22 mm

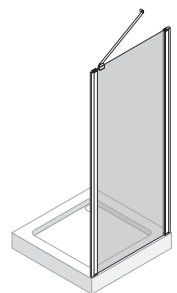

Cariba® dimensions



(Diagram shows 2 round door leaves)
Profile outer edge to be set back by 15 mm
Glass outer edge to be set back by 22 mm



Can also be combined with round door leaf CR4 and side wall SW1A on the hinged side (U-shaped cabin).



(Diagram shows 2 round door leaves)
Profile outer edge to be set back by 15 mm
Glass outer edge to be set back by 22 mm



Can also be combined with round door leaf CR2 and side wall SW1A on the hinged side (U-shaped cabin).

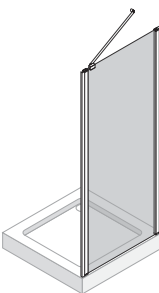

Profile outer edge to be set back by 15 mm
Glass outer edge to be set back by 22 mm

Round door leaf without fixed element		CR2	NEW		
Mat. no.	Model	Height	Tray installation dimensions	Access width approx.	Type
1115009314	Cariba® round door leaf without fixed elem. 800 r=500	2000	780 - 805	540	CR280R50
1115009316	Cariba® round door leaf without fixed elem. 800 r=550	2000	780 - 805	530	CR280R55
1115009318	Cariba® round door leaf without fixed elem. 900 r=500	2000	880 - 905	640	CR290R50
1115009320	Cariba® round door leaf without fixed elem. 900 r=550	2000	880 - 905	625	CR290R55

All dimensions in mm

Round door leaf with fixed element		CR4	NEW		
Mat. no.	Model	Height	Tray installation dimensions	Access width approx.	Type
1115009322	Cariba® round door leaf with fixed element 750 r=500	2000	730 - 755	330	CR475R50
1115009324	Cariba® round door leaf with fixed element 800 r=500	2000	780 - 805	330	CR480R50
1115009326	Cariba® round door leaf with fixed element 800 r=550	2000	780 - 805	365	CR480R55
1115009328	Cariba® round door leaf with fixed element 900 r=500	2000	880 - 905	330	CR490R50
1115009330	Cariba® round door leaf with fixed element 900 r=550	2000	880 - 905	365	CR490R55
1115009332	Cariba® round door leaf with fixed element 1000 r=500	2000	980 - 1005	330	CR4100R50
1115009334	Cariba® round door leaf with fixed element 1000 r=550	2000	980 - 1005	365	CR4100R55
1115009336	Cariba® round door leaf with fixed element 1200 r=500	2000	1180 - 1205	330	CR4120R50
1115009338	Cariba® round door leaf with fixed element 1200 r=550	2000	1180 - 1205	365	CR4120R55
1115009340	Cariba® round door leaf with fixed elem., indiv. dim. r=500	2000	up to 1250	330	CR4R50SONDER
1115009342	Cariba® round door leaf with fixed elem., indiv. dim. r=550	2000	up to 1250	365	CR4R55SONDER

All dimensions in mm

Side wall on the hinged side		SW1A	NEW		
Mat. no.	Model	Height	Tray installation dimensions	Type	
1115009368	Cariba® side wall on the hinged side 700	2000	680 - 705	CSW1A70	
1115009370	Cariba® side wall on the hinged side 750	2000	730 - 755	CSW1A75	
1115009372	Cariba® side wall on the hinged side 800	2000	780 - 805	CSW1A80	
1115009374	Cariba® side wall on the hinged side 900	2000	880 - 905	CSW1A90	
1115009376	Cariba® side wall on the hinged side 1000	2000	980 - 1005	CSW1A100	
1115009378	Cariba® side wall on the hinged side 1200	2000	1180 - 1205	CSW1A120	
1115009380	Cariba® side wall on the hinged side, indiv. dim.	up to 2000	up to 1250	CSW1ASONDER	
1115009394	Cariba® bath tub side wall, individual dim.	up to 2000	up to 1250	CSW1ASSONDER	

All dimensions in mm

Cariba® dimensions

Pentagonal door leaf with fixed element CF4 NEW						
Mat. no.	Model	Height	Tray installation dimensions	Access width approx.	Type	
1115009344	Cariba® pentagonal door leaf w. fixed elem. 900 tray side=400	2000	883 - 908	325	CF490S40	
1115009346	Cariba® pentagonal door leaf w. fixed elem. 900 tray side=450	2000	883 - 908	290	CF490S45	
1115009348	Cariba® pentagonal door leaf w. fixed elem. 1000 tray side=500	2000	983 - 1008	325	CF4100S50	
1115009350	Cariba® pentagonal door leaf w. fixed elem., indiv. dim.	up to 2000	up to 1100		CF4SONDER	

All dimensions in mm

Can also be combined with side wall SW1A on the hinged side (U-shaped cabin).

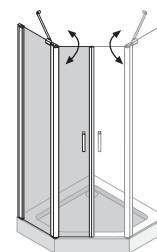

(Diagram shows 2 pentagonal door leaves)
Profile outer edge to be set back by 15 mm
Glass outer edge to be set back by 22 mm

Bath tub screen without fixed element B1 NEW				
Mat. no.	Model	Height	Tray installation dimensions	Type
1115009352	Cariba® bath tub screen without fixed element 700	1500	690 - 715	CB170
1115009354	Cariba® bath tub screen without fixed element 750	1500	740 - 765	CB175
1115009356	Cariba® bath tub screen without fixed element 800	1500	790 - 815	CB180
1115009358	Cariba® bath tub screen without fixed element, indiv. dim.	up to 1500	up to 850	CB1SONDER

All dimensions in mm

Can also be combined with bath tub side wall CSW1ASSONDER with individual dimensions.

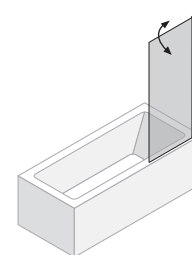

Profile outer edge to be set back by 15 mm
Glass outer edge to be set back by 22 mm

Bath tub screen with fixed element B2A NEW				
Mat. no.	Model	Height	Tray installation dimensions	Type
1115009360	Cariba® bath tub screen with fixed element 1000	1500	987 - 1012	CB2A100
1115009362	Cariba® bath tub screen with fixed element 1200	1500	1187 - 1212	CB2A120
1115009364	Cariba® bath tub screen with fixed element 1400	1500	1387 - 1412	CB2A140
1115009366	Cariba® bath tub screen with fixed element, indiv. dim.	up to 1500	up to 1450	CB2ASONDER

All dimensions in mm

Can also be combined with bath tub side wall CSW1ASSONDER with individual dimensions.

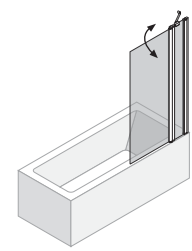

Profile outer edge to be set back by 15 mm
Glass outer edge to be set back by 22 mm

Side wall on the hinged side SW1A NEW				
Mat. no.	Model	Height	Tray installation dimensions	Type
1115009368	Cariba® side wall on the hinged side 700	2000	680 - 705	CSW1A70
1115009370	Cariba® side wall on the hinged side 750	2000	730 - 755	CSW1A75
1115009372	Cariba® side wall on the hinged side 800	2000	780 - 805	CSW1A80
1115009374	Cariba® side wall on the hinged side 900	2000	880 - 905	CSW1A90
1115009376	Cariba® side wall on the hinged side 1000	2000	980 - 1005	CSW1A100
1115009378	Cariba® side wall on the hinged side 1200	2000	1180 - 1205	CSW1A120
1115009380	Cariba® side wall on the hinged side, individual dim.	up to 2000	up to 1250	CSW1ASONDER
1115009394	Cariba® bath tub side wall, individual dimensions	up to 2000	up to 1250	CSW1ASSONDER

All dimensions in mm

Can only be combined with all niche doors and as an additional side wall for corner, round and pentagonal solutions (U-shaped cabins).

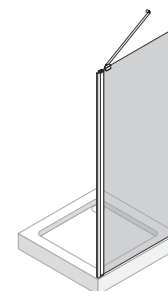

Profile outer edge to be set back by 15 mm
Glass outer edge to be set back by 22 mm

Cariba® Room dimensions

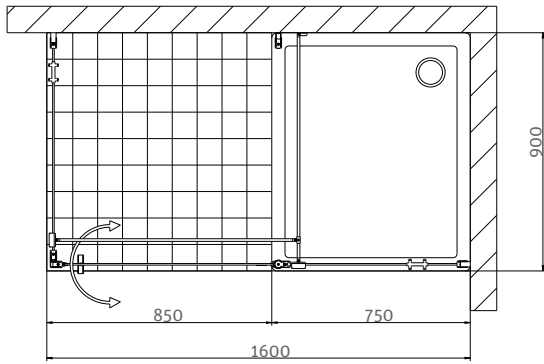

1600 × 900 mm

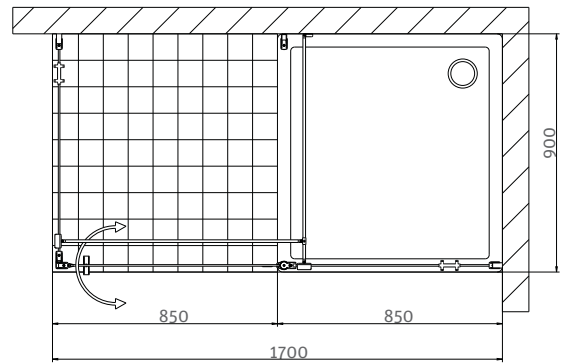

1700 × 900 mm

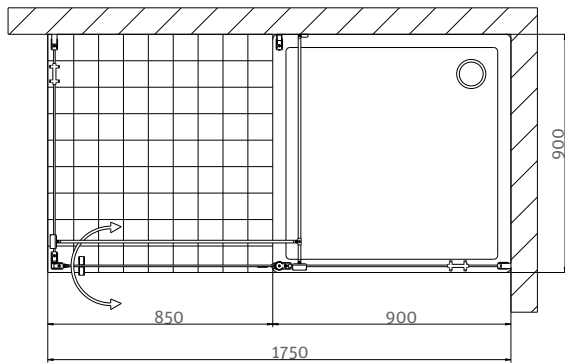

1750 × 900 mm

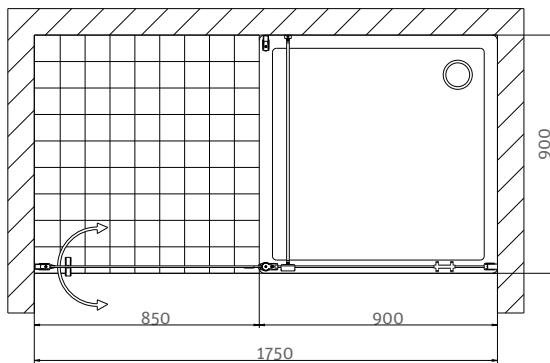

Niche: 1750 × 900 mm

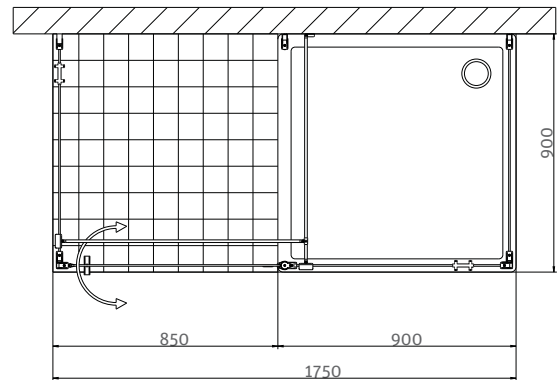

Cabin: 1750 × 900 mm

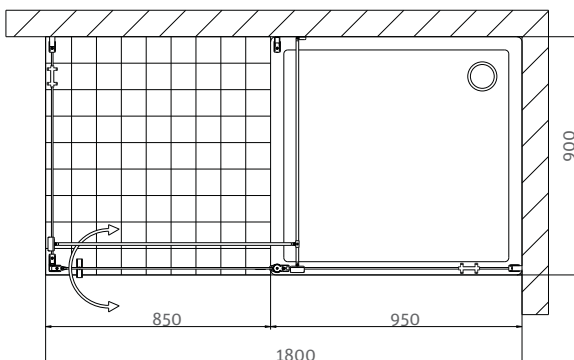

1800 × 900 mm

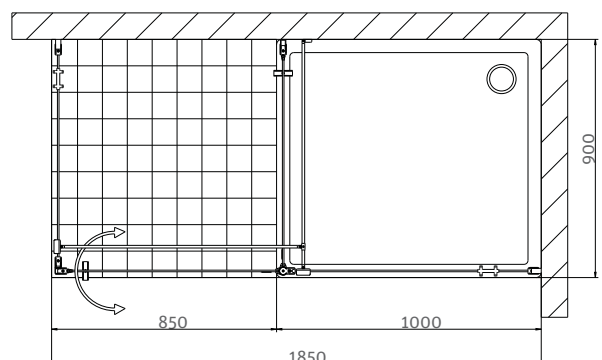

1850 × 900 mm

Replacement seals for Roth glass showers

Drawing	Material description	Material number
	Roth labyrinth seal/L: 2010 mm/Gala®/Laguna® Maxi Wave	1150005301
	Roth door seal profile/L: 2010 mm/180 degrees with Magnet/Gala®/Magna/Laguna®	1150001472
	Roth magnetic door seal/L: 2210 mm/90 degrees left /Gala® E,S/ Magna E/Laguna® E/Maxi E,S	1150001464
	Roth magnetic door seal/L: 2210 mm/90 degrees right /Gala® E,S/ Magna E/Laguna® E/Maxi E,S	1150001465
	Roth tray seal/L: 1300 mm transparent/Laguna® 1 pentagonal Note: 2 tray seals are required for each pentagonal shower!	1150000942
	Roth tray seal/L: 1300 mm transparent/Gala®/Laguna® 2 pentagonal Note: 2 tray seals are required for each pentagonal shower!	1150003632
	Roth tray seal/L: 1717 mm transparent/Gala®/Laguna® 2 round Note: 1 tray seal is required for each quadrant-shaped shower and 2 tray seals are required for each semi-circular shower!	1150003631
	Roth tray seal/L: 1717 mm transparent/Laguna® 1/Magna round Note: 1 tray seal is required for each quadrant-shaped shower and 2 tray seals are required for each semi-circular shower!	1150000941
	Roth tray seal/L: 1900 mm transparent/Gala®/Laguna® 2 straight	1150003630
	Roth tray seal/L: 1900 mm transparent/Laguna® 1/Magna straight	1150000940

Tempofit technical data and dimensions

Tempofit Corner

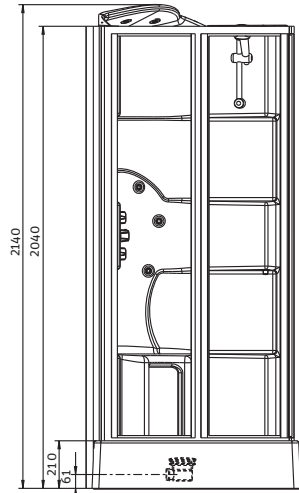

shown without top

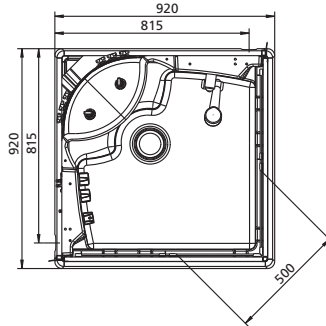

Sliding door, 2 pieces

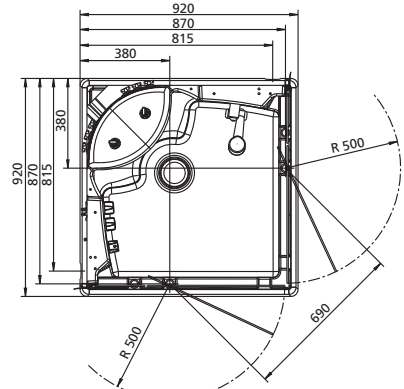

Swing door, 2 pieces

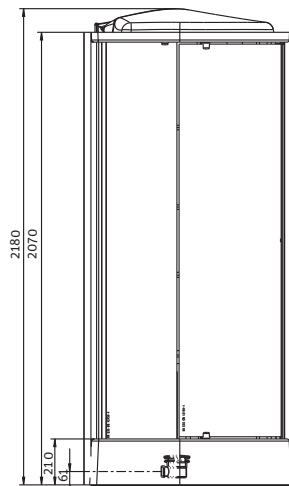

shown with top

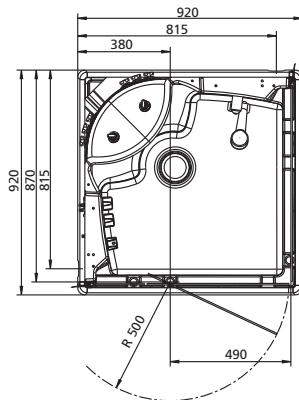

Swing door (l.) with side wall (r.)

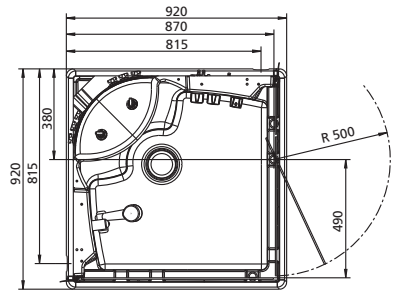

Swing door (r.) with side wall (l.)

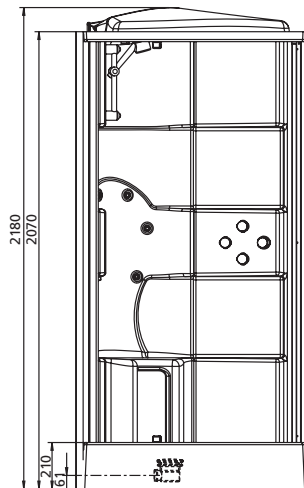

shown with top

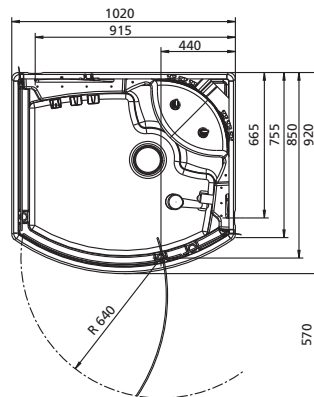

Swing door (r.) with side wall (l.)

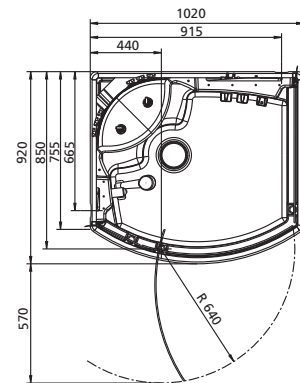

Swing door (l.) with side wall (r.)

Tempofit technical data and dimensions

Tempofit Round

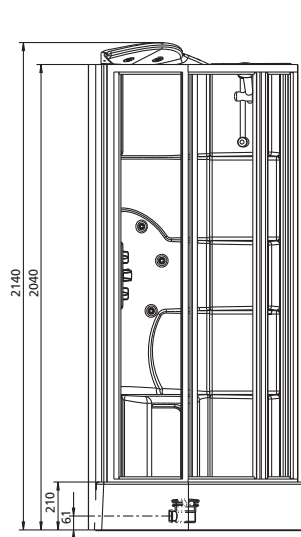

shown without top

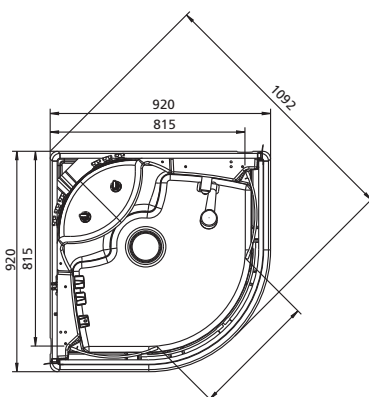

Sliding door, 2 pieces

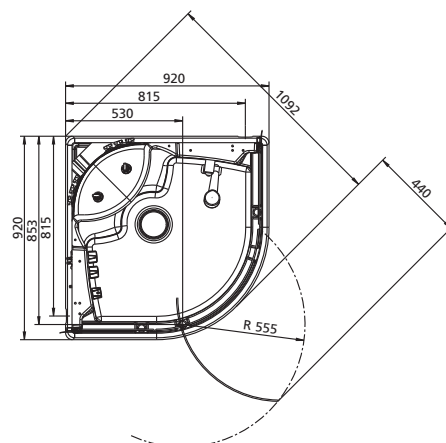

Swing door, 1 piece (l.)

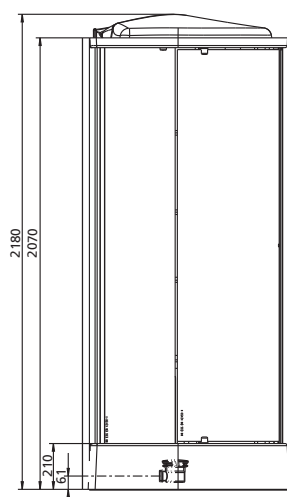

shown with top

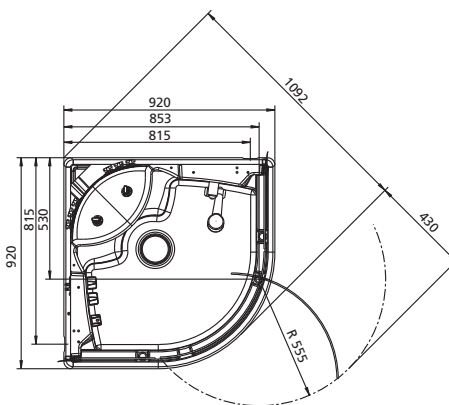

Swing door, 1 piece (r.)

Technical data for steam generator

The steam generator has a self-regulating water flow and level control system. When the steam generator is switched off, an automatic rinsing program controls the cleaning process and ensures that the generator is completely empty. A safety thermostat monitors its operation. The steam generator has an automatic cut-out which is activated after approx. 45 minutes. The device can be serviced via an inspection opening inside the cabin.

Rated voltage:	220 - 240 V AC
Rated output:	2750 W
Frequency:	50 Hz
Fuse protection:	16 A
Cable cross-section:	3 × 2,5 mm ²
Steam output:	4 kg/h

Space required

The Tempofit complete showers are designed for installation in a corner of the room. The space required at the installation site can be taken from the cabin drawings provided. Please note that access from all sides is essential for installing the cabin. The required room height for Tempofit complete showers without a top is 2160 mm. The required room height for Tempofit complete showers with a top is 2250 mm.

Tempofit technical data and dimensions

■ Equipment: Shower function with compact continuous flow heater

1 corner panel with seat, 2 side wall panels with moulded shelves, 1 single-lever mixer, 1 slide bar with holder for handheld shower head, 1 handheld shower head with normal, massage and eco-spray as well as cleaning function, 1 flexible shower head hose, 1,25 m, 1 soap dish, 1 chrome-plated shower head holder, 1 flow heater, 1 inspection cover.

■ Equipment: Shower function with automatic pump

1 corner panel with seat, 2 side wall panels with moulded shelves, 1 thermostat mixer, 1 shut-off valve, 1 slide bar with holder for handheld shower head, 1 handheld shower head with normal, massage and eco-spray as well as cleaning function, 1 flexible shower head hose, 1,25 m, 1 soap dish, 1 chrome-plated shower head holder, 1 shower tray with integrated pump.

■ Equipment: Shower function with compact continuous flow heater and automatic pump

1 corner panel with seat, 2 side wall panels with moulded shelves, 1 single-lever mixer, 1 slide bar with holder for handheld shower head, 1 handheld shower head with normal, massage and eco-spray as well as cleaning function, 1 flexible shower head hose, 1,25 m, 1 soap dish, 1 chrome-plated shower head holder, 1 flow heater, 1 inspection cover, 1 shower tray with integrated pump.

■ Technical data for fittings

Tempofit complete showers are all equipped with a thermostat fitting and associated shut-off valves. Once installed, the thermostat fitting keeps the preset water temperature constant, irrespective of flow, supply temperature and pressure fluctuations.

The only exceptions are Tempofit complete showers with an integrated flow heater. A single-lever mixer is fitted in this equipment option. With this fitting, the temperature can be adjusted more effectively at lower flow volumes.

■ Compact continuous flow heater

The flow heater is an electrical device. It produces hot water for the shower. The integrated flow heater is an electrical device, which means that the heat output is regulated continuously and the temperature is kept constant, irrespective of the flow and supply temperature. Furthermore, by automatically adjusting the heat output, the electronic heat control uses less energy than hydraulic devices. The electronic flow heater is already integrated into the water supply of the Tempofit complete shower. No further actions are required to operate the device after it has been properly installed. Another tap can also be connected next to the hot water supply of the Tempofit complete shower. The device can be serviced via an inspection opening inside the cabin.

Rated voltage: 3/PE 380 - 415 V AC

Rated output: 11.000 W

Rated current: 3 × 16 A

Frequency: 50/60 Hz

Fuse protection: 3 × 16 A

Required wire cross-section: 2,5 mm²

Hot water output at $\Delta t = 4,8$ l/min

Capacity: 0,3 l

Design: closed

Heating system: bare wire

Rated overpressure: 1 MPa (10 bar)

Area of application (specific water resistance at 15 °C): $\geq 1000 \Omega$ cm

Tempofit technical data and dimensions

■ Automatic pump

The pump is an electrical device. When necessary, the pump delivers the waste water that collects during showering into a suitable water drainage system through a discharge hose. The pump is integrated into the shower tray and is activated automatically when water flows in. The maximum delivery height of the pump is 1,50 m. When the pump is operating, the volume of water brought in must correspond to the pump output. Otherwise water will build up in the shower tray. As well as draining the Tempofit complete shower, waste water, such as from a hand basin, can also be fed into the drainage system. The device can be serviced via an inspection opening inside the shower tray.

Rated voltage: 1/N/PE 220 - 240 V AC

Rated output: 40 W

Rated current: 0,25 A

Frequency: 50 Hz

Fuse protection: 16 A

Required wire cross-section: 1,5 mm²

Reference values for delivered volume: 25 l/min at 0,5 m delivery height

20 l/min at 1,0 m delivery height

15 l/min at 1,5 m delivery height

■ Water connection

Connection for cold/hot water: min. DN 15 or 1/2" outer thread

Operating pressure: min. 200 kPa – max. 500 kPa (2-5 bar)

Recommended operating pressure: 300 kPa (3 bar)

If necessary, an pressure reducer can be fitted on site.

Pressure differences between hot and cold water must be equalised.

Cold water temperature: max. 30 °C

Hot water temperature: max. 70 °C

Recommended hot water temperature: 60 °C

A shut-off device should be installed on both water connections and a water damage protection valve should also be installed on site. For the model with a steam generator, a check valve must also be installed on site in the cold water supply. The openings made in the wall for the water connections during installation must be sealed with elastic caulking. The system must be rinsed in accordance with DIN 1988. Fully deionised water must not be fed into the system.

■ Operation with your own flow heaters

Tempofit **complete showers without integrated compact continuous flow heaters** can be operated using hydraulic, electrical or thermal flow heaters (min. 24 kW). The flow must be at least 12 l/min at 300 kPa (3 bar).

■ Waste water connection

The waste water connection pipe is to be provided according to the diagrams of the installation areas. The dimensions of the waste water pipe must be at least DN 40.

In models with a pump, the waste water is pumped through a discharge hose (inner diameter 19 mm) into a suitable drainage system. The maximum delivery height of the pump is 1,50 m. The discharge hose can be extended by up to 12 m when laid horizontally. The specified hose cross-section must be observed for this connection. The specified reference values for delivered volumes and delivery heights may be reduced depending on the distance to be pumped and the hose orientation. For the best possible delivery results, pump vertically upwards initially to the maximum required height directly after the pump and lay the rest of the delivery route to the drainage system with a slight downward slope.

Tempofit technical data and dimensions

■ Electrical connection for steam generator

Power supply: 1/N/PE 220–240 V AC/50 Hz/16 A
Max. power consumption: 2750 W

For the electrical connection, a separate $3 \times 2,5 \text{ mm}^2$ circuit wire and a $1 \times 4 \text{ mm}^2$ wire are to be provided for potential equalisation. When the system is installed, the power supply must be routed through an all-pole disconnection device (e.g. via fuses) with a contact opening width of at least 3 mm per pole and a residual current protection device (residual current circuit breaker) with $I_{FN} \leq 30 \text{ mA}$. The potential equalisation is to be conductively connected to the potential equalisation of the house wiring. The system must be grounded in accordance with VDE 0100 Sections 410 and 540. The cabin is fitted with a 2-metre connection cable (HOVV-F 3G2.5) for connection to the fixed electric socket as shown in the diagrams in Point 6.2.

■ Electrical connection for compact continuous flow heater and automatic pump

Power supply: 3/N/PE 380–415 V AC/50 Hz/16 A
Max. power consumption: 11.040 W

A separate $5 \times 2,5 \text{ mm}^2$ circuit wire is to be provided for the electrical connection. When the system is installed, the power supply must be routed through an all-pole disconnection device (e.g. via fuses) with a contact opening width of at least 3 mm per pole and a residual current protection device (residual current circuit breaker) with $I_{FN} \leq 30 \text{ mA}$. A socket is specified for connecting the power supply. The specific water resistance of the water supply network must not be less than $1000 \Omega \text{ cm}$.

■ Electrical connection for compact continuous flow heater

Power supply: 3/PE 380–415 V AC/50 Hz/16 A
Max. power consumption: 11.000 W

The device must be permanently connected to the fixed installation wires. A separate $4 \times 2,5 \text{ mm}^2$ circuit wire is to be provided for the electrical connection. When the system is installed, the power supply must be routed through an all-pole disconnection device (e.g. via fuses) with a contact opening width of at least 3 mm per pole and a residual current protection device (residual current circuit breaker) with $I_{FN} \leq 30 \text{ mA}$. The device must be connected to the earth wire. A socket is specified for connecting the power supply. The specific water resistance of the water supply network must not be less than $1000 \Omega \text{ cm}$.

■ Electrical connection for automatic pump

Power supply: 1/N/PE 220–240 V AC/50 Hz/16 A
Max. power consumption: 40 W

A $3 \times 1,5 \text{ mm}^2$ circuit wire is to be provided for the electrical connection. When the system is installed, the power supply must be routed through an all-pole disconnection device (e.g. via fuses) with a contact opening width of at least 3 mm per pole and a residual current protection device (residual current circuit breaker) with $I_{FN} \leq 30 \text{ mA}$. A socket is specified for connecting the power supply.

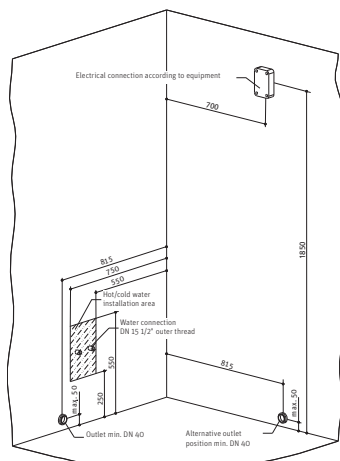

Installation sketch for Tempofit Corner and Round 920 x 920

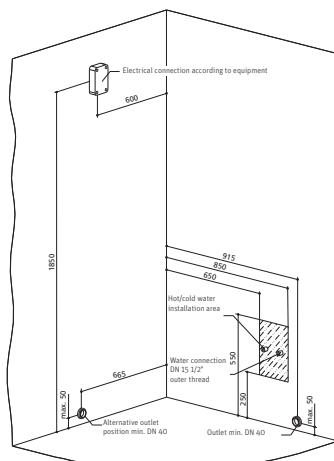

Installation sketch for Tempofit Corner 1020 x 755

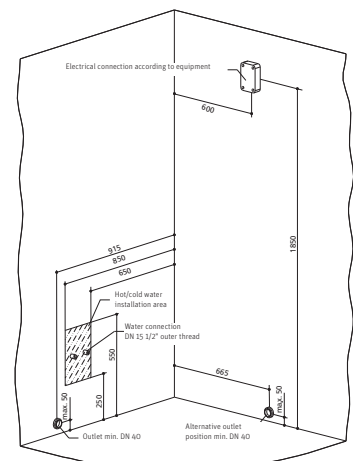

Installation sketch for Tempofit Corner 755 x 1020

Exklusiv technical data

■ Model with hot water boiler (low pressure)

Output: 2000 watts
Capacity: 16,4 litres, heating time: approx. 30 minutes
Average shower time for one boiler filling: approx. 8 to 10 minutes

A water supply hose is provided for connecting to a water tap or angle valve. A water damage protection valve should be installed on site. The in-built restrictor is intended for dynamic pressure regulation with a water line pressure of 2 to 6 bar. The water flow is 4,5 l/min.

■ Model with pump

40-watt pump: delivery height 1500 mm
150-watt pump: delivery height 2200 mm (reinforced)

A drain hose and compatible hose clamp are provided. In the 150-watt pump model, the drain hose is supplied with a check valve.

■ Electrical connection

The electrical connection must be made by licensed electrician. The connection (connection value max. 2150 W, AC 230 V, 50 Hz) with a rubber hose line must be routed through an all-pole circuit breaker with a contact distance of at least 3 mm and a residual current protection device (residual current circuit breaker) with IFN < 30 mA. The potential equalisation is to be conductively connected to the potential equalisation of the house wiring.

■ Activating the pump

When the pump is operating, the volume of water brought in must correspond to the pump output. Otherwise water will build up in the shower tray.

Reference values: 40-watt pump
Delivery height: 0,5 m - 20 litres
1,0 m - 15 litres
1,5 m - 11 litres

Reference values: 150-watt pump
Delivery height: 0,5 m - 17 litres
1,0 m - 14 litres
1,5 m - 13 litres
2,0 m - 11 litres
2,5 m - 8 litres



Individual designs, accessories, additional equipment

Exklusiv individual designs / accessories

- > 150-watt reinforced pump (delivery height 2200 mm instead of 1500 mm)
- > Flexible 500-mm (3/8") connection hose for models without a boiler
- > Flexible 1250-mm (3/8") connection hose for models without a boiler

Exklusiv individual designs / accessories

- > Wall connection cover (curtain type), width 70 mm
- > Wall connection cover (other door types), width 65 mm
- > Shortening (curtain type)
Shortening (other door types)
Doors can be shortened by 80, 120, 150, 180, 220 or 260 mm, on the basis of a total height of 2050 mm and a standard height of 1900 mm

Exklusiv additional equipment (for an additional charge)

- > Chrome-plated single-lever high-pressure mixer for models without boiler
- > Chrome-plated single-lever low-pressure mixer for models without boiler

Exklusiv technical data and dimensions

The room height required for installation is 2100 mm.

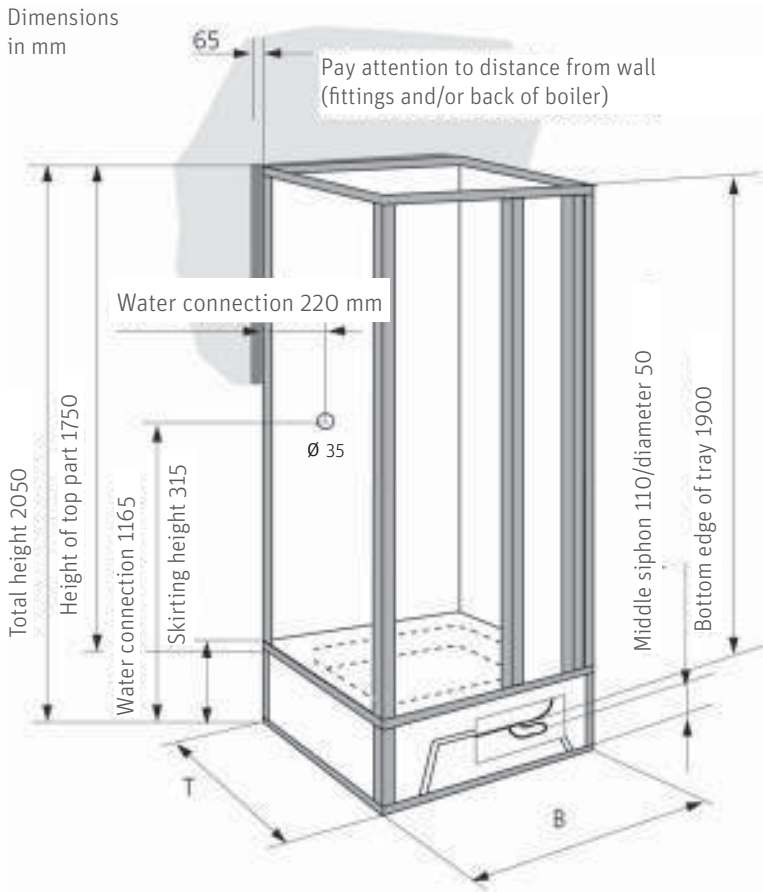

Exklusiv access types

Curtain

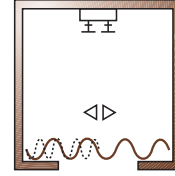

Access widths
845 x 840 = approx. 590 mm
745 x 745 = approx. 490 mm

Swing door, 1 piece

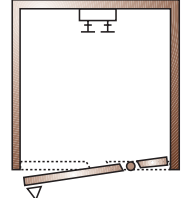

Access widths
845 x 845 = approx. 590 mm
745 x 745 = approx. 540 mm

Folding door, 2 pieces

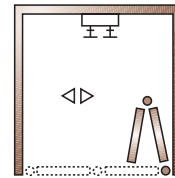

Access widths
845 x 845 = approx. 680 mm
745 x 745 = approx. 580 mm
795 x 845 = approx. 630 mm
945 x 945 = approx. 780 mm

Sliding door, 3 pieces

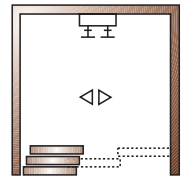

Access widths
845 x 845 = approx. 480 mm
795 x 845 = approx. 450 mm
945 x 945 = approx. 550 mm

Corner access, 2 pieces right

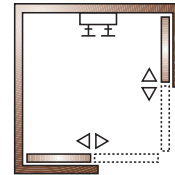

Access widths
845 x 845 = approx. 480 mm

Corner access, 2 pieces left

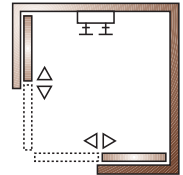

Access widths
845 x 845 = approx. 480 mm

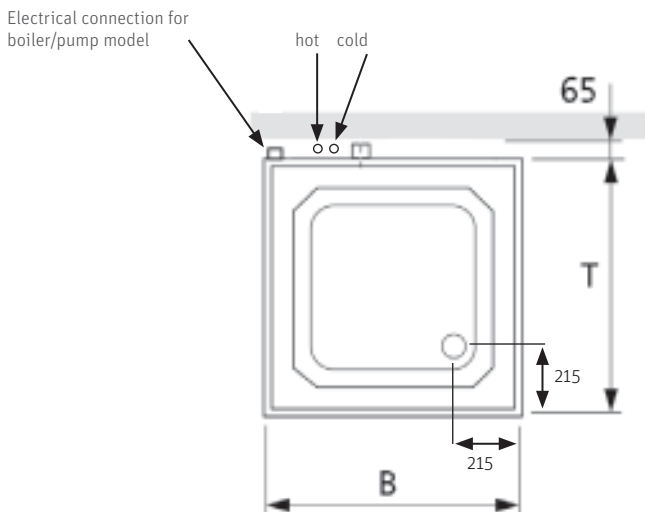

Exklusiv - outside dimensions (tray dimensions)	
Width B	Depth T
845 (800)	845 (800)
745 (700)	745 (700)
795 (750)	845 (800)
945 (900)	945 (900)

All dimensions in mm



Exklusiv technical data and dimensions with low access



The room height required for installation is 2100 mm.

Exklusiv access types

Dimensions in mm

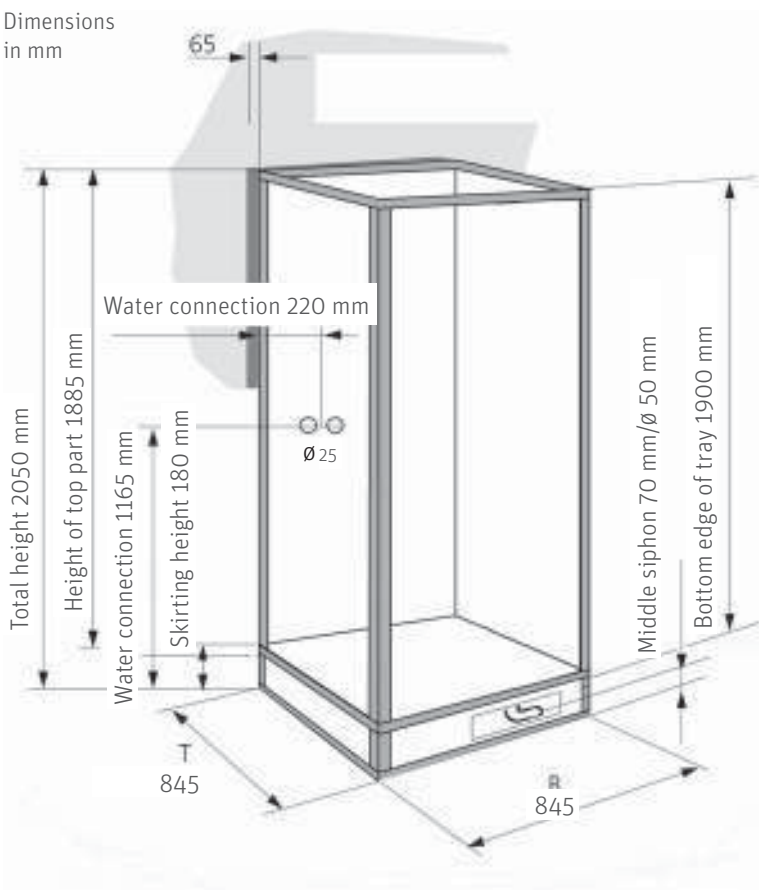

Swing door, 2 pieces

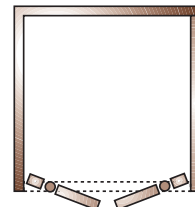



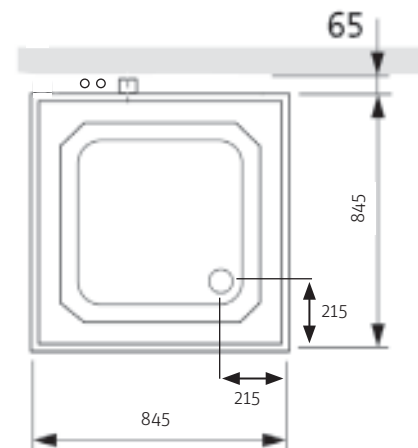







Access width approx. 650 mm





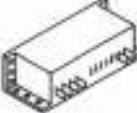







Spare parts for Roth Exklusiv complete showers

Drawing	Material description	Material number
	Roth hot water boiler/16,4 litres/L: 600 mm with accessories/Exklusiv BP Including heating element, control thermostat, safety thermostat	1125001500
	Roth hot water boiler/20 litres/L: 540 mm with accessories/Exklusiv BP Including heating element, control thermostat, safety thermostat	1125001812
	Roth hot water boiler/20 litres/L: 490 mm with accessories/Exklusiv BP Including heating element, control thermostat, safety thermostat	1125001811
	Roth hot water boiler/11 litres/L: 450 mm with accessories/Exklusiv BP Including heating element, control thermostat, safety thermostat For bottom part size 700 × 700 (745 × 745) mm	1125001810
	Roth heating element/Exklusiv BP with flange gasket and earth cable	1125002355
	Roth control thermostat/Exklusiv with accessories	1125001562
	Roth safety thermostat/Exklusiv	1125001920
	Roth discharge pump/40 W/without accessories for Exklusiv BP For all pump models up to 80 W	1125001450
	Roth discharge pump/150 W/without accessories for Exklusiv BP	1125001643
	Roth automatic relay/with cable set for Exklusiv BP	1125001890
	Roth mixer tap/two-handle, high-pressure for Exklusiv For models without hot water boiler	1150000164

Spare parts for Roth Exklusiv complete showers

Drawing	Material description	Material number
	Roth mixer tap/two-handle, low-pressure for Exklusiv For models with a hot water boiler	1150000166
	Roth mixer tap/single-lever, high-pressure for Exklusiv For models without hot water boiler	1150000165
	Roth mixer tap/single-lever, low-pressure for Exklusiv For models with a hot water boiler	1150000167
	Roth wheeled bracket set/complete folding door/Exklusiv	1125001453
	Roth wheeled bracket and slider set/complete sliding door made from 1997 onwards/Exklusiv	1125001866
	Roth wheeled bracket and slider set/complete sliding door made before 1997/Exklusiv	1125001452
	Roth latch bearing/2-piece swing door Exklusiv TP/old model	1125001451
	Roth discharge elbow for Exklusiv bottom part with manual pump	1125001816
	Roth discharge elbow for Exklusiv bottom part with automatic pump	1125001434
	Roth shower set, chrome, single-spray L: 570 mm (slide rail, handheld shower head and shower hose)	1150001749

References

Example – unusual installations

Laguna® Maxi Wave E4 with extended handrail 40 × 60 mm



Our strengths

Your benefits

Innovation

- > Early identification of market requirements
- > In-house materials research and development
- > In-house engineering

Service

- > Extensive field network of qualified sales professionals
- > Hotline and project planning service
- > Factory training courses, planning and product seminars
- > Fast availability of all Roth brand product ranges throughout Europe
- > Comprehensive warranty and extended liability agreements

Products

- > Complete range of easy-to-install product systems
- > Manufacturing expertise for the complete product range within the Roth Industries group of companies
- > All products and product systems are certified in accordance with DIN EN ISO 9001:2008





Roth Energy and Sanitary Systems

Generation

- > Solar systems
- > Heat pump systems
- > Solar heat pump systems

Storage

- Storage systems for
- > Domestic and heating water
 - > Combustibles and biofuels
 - > Rainwater and waste water

Application

- > Radiant heating and cooling systems
- > Pipe installation systems
- > Shower systems

